

# Dell™ PowerVault™ 122T DLT VS80 Autoloader User's Guide

[Introduction](#)

[Installing the Autoloader](#)

[Operating the Autoloader](#)

[Autoloader Administration](#)

[Diagnostics and Troubleshooting](#)

[Technical Specifications](#)

[Contacting Dell](#)

[Getting Help](#)

[Regulatory](#)

---

## Notes, Notices, and Cautions

Throughout this guide, blocks of text may be accompanied by an icon and printed in bold type or in italic type. These blocks are notes, notices, and cautions, and they are used as follows:



**NOTE:** A NOTE indicates important information that helps you make better use of your system.



**NOTICE:** A NOTICE indicates either potential damage to hardware or loss of data and tells you how to avoid the problem.



**CAUTION:** A CAUTION indicates a potentially hazardous situation which, if not avoided, could result in death or serious bodily injury.

---

Information in this document is subject to change without notice.

© 2002-2004 Dell Inc. All rights reserved.

Reproduction in any manner whatsoever without the written permission of Dell Inc. is strictly forbidden.

Trademarks used in this text: *Dell*, the *DELL* logo, *PowerVault*, *Dimension*, *Inspiron*, *OptiPlex*, *Latitude*, *Dell Precision*, *PowerApp*, *PowerEdge*, *PowerConnect*, *Axim*, and *DellNet* are trademarks of Dell Inc.; *Microsoft*, *Windows*, and *Windows NT* are registered trademarks of Microsoft Corporation.

Other trademarks and trade names may be used in this document to refer to either the entities claiming the marks and names or their products. Dell Inc. disclaims any proprietary interest in trademarks and trade names other than its own.

---

Initial Release: Jun 2002

Last revised: Feb 2004

## Autoloader Administration: Dell™ PowerVault™ 122T DLT VS80 Autoloader User's Guide

- [Configuring the Autoloader](#)
  - [Updating Firmware](#)
  - [Running the Autoloader System Test](#)
  - [Retrieving Information About the Autoloader](#)
- 

### Configuring the Autoloader

The **Configuration** menu options enable you to perform the following tasks:

- 1 Resetting the autoloader
- 1 Setting SCSI IDs
- 1 Autoloader operating modes
- 1 Updating firmware

To access the **Configuration** menu from the Home screen or main menu, press + or - until **Configuration** appears on the top line of the LCD screen. Press **Enter**, and then + or - to access the available options. Press **Enter** to execute the displayed menu option.

### Resetting the Autoloader

This option resets the autoloader robotics and the tape drive within the autoloader, forces a new cartridge inventory, and clears any current error condition.

 **NOTE:** This option is primarily used if the autoloader is in an error state.

To access this option, follow these steps:

1. From the Home screen or main menu, press + or - until **Configuration** appears on the top line of the LCD screen, and then press **Enter**.
2. Press + or - until **Reset** appears on the LCD screen.
3. Press **Enter** to reset the autoloader.
4. After initialization, the autoloader returns to normal operation and displays the Home screen.

### Changing the SCSI ID

This option changes the SCSI ID the autoloader uses. The autoloader operates as a single SCSI device with two Logical Unit Numbers (LUNs), one LUN (0) is for the tape drive, the other (1) is for the autoloader robotics.

The default SCSI ID is 6. You should only need to change the SCSI ID if there is another device on the SCSI bus with the same SCSI ID.

To access this option, follow these steps:

1. From the Home screen or main menu, press + or - until **Configuration** appears on the top line of the LCD screen, and then press **Enter**.
2. Press + or - until **Change SCSI ID** appears on the LCD screen. The second line displays the current SCSI ID.
3. Press **Enter**. The second line on the LCD screen displays **New ID:**.
4. Press + or - until the desired SCSI ID displays.
5. Press **Enter**. The LCD screen displays **Please Cycle Power**.

 **NOTE:** The autoloader will not respond to input from the operator panel until the power has been cycled.

6. Turn off the autoloader. After a few seconds, turn it back on again.

The selected SCSI ID is now in effect.

 **NOTE:** If you changed the SCSI ID, you may also need to reboot the host server and reconfigure your backup software before you can use the autoloader. Consult your hardware and software manuals for more information.

## Autoloader Operating Modes

### Overview

The operating mode is set based on whether you have automation software controlling cartridges in the autoloader or if you are manually loading and unloading cartridges using the autoloader Operator's Panel commands. The autoloader always operates in Autodetect Mode, which is transparent to you. In Autodetect Mode, the autoloader automatically assumes that you *are not* using an automation software package to control cartridge or drive activity. This is called Stacker or Sequential Mode. If the autoloader detects that an automation software package is controlling tape/drive activity, it will automatically switch to Random mode.

### Random Mode

This is the normal mode of operation when a backup software application is being used. In Random Mode, the autoloader will not automatically load tapes into the drive; it instead waits for commands from the software. To use Random Mode, you do not need to configure anything from the autoloader front panel, but your backup software package must support autoloaders, which often requires the additional installation of an autoloader/library software module.

### Sequential Mode

Sequential Mode is useful when an adequate software application is not available. In Sequential Mode, the autoloader will automatically unload and load tapes from the drive. The operator determines the first tape to load by loading the desired tape into the tape drive using the autoloader's front panel controls (see "[Loading Cartridges](#)"). When the first tape is full or unloaded for any other reason, the autoloader automatically removes the tape from the drive, puts it in its original slot, then loads the next available higher numbered slot, continuing this sequence with each available higher numbered slot. To further determine how you want tapes loaded into the autoloader's tape drive while in Sequential mode, you may set **Circular** and **Autoload** options from the autoloader front panel. When the autoloader is in Sequential Mode, the LCD will display `seq` in the lower-right corner of the display.

### Circular Mode On/Off

This option turns Circular Mode on or off, and is only used when in Sequential Mode. When Circular Mode is on, after the autoloader has cycled through all available cartridges, it then reloads the original first cartridge in the sequence. If Circular Mode is turned off and the last cartridge has been unloaded, the autoloader stops loading cartridges until you manually load another cartridge.



**NOTICE:** Use caution when choosing Circular Mode as it makes it possible to overwrite data on previously written cartridges.

To access this option, follow these steps:

1. From the Home screen or main menu, press + or - until `Configuration` appears on the top line of the LCD screen, and then press **Enter**.
2. Press + or - until `Circular Mode` appears on the LCD screen. The second line on the LCD screen indicates the current status, either `on` or `off`.
3. Press **Enter**. The LCD screen indicates whether you are about to turn Circular Mode on or off.
4. Press **Enter** to accept the change to Circular Mode or **Cancel** to exit and not save the changes.

### Autoload Mode On/Off

This option turns Autoload Mode on or off, and is only used when in Sequential Mode. When Autoload Mode is on, the autoloader automatically loads the cartridge from the lowest-numbered full slot into the tape drive when powered on. It then follows standard sequential operation as described above.

To access this option, follow these steps:

1. From the Home screen or main menu, press + or - until `Configuration` appears on the top line of the LCD screen, and then press **Enter**.
2. Press + or - until `Autoload Mode` appears on the LCD screen. The second line on the LCD screen indicates the current status, either `on` or `off`.
3. Press **Enter**. The LCD screen indicates whether you are about to turn Autoload Mode on or off.
4. Press **Enter** to accept the change to Autoload Mode or **Cancel** to exit and not save the changes.

---

## Updating Firmware



**NOTICE:** Regardless of the firmware update technique, do not power cycle or reset the autoloader during the upgrade process. Doing so could cause the autoloader to become inoperable.

### Using a Firmware Upgrade Tape

This option performs a firmware code update on the autoloader using a firmware upgrade cartridge.



**NOTE:** This code update operation assumes that the upgrade tape is imported as part of this procedure. Do not import the firmware update cartridge before starting this procedure.

To use this option, follow these steps:

1. From the Home screen or main menu, press + or - until `Configuration` appears on the top line of the LCD screen, and then press **Enter**.
2. Press + or - until `Code Update` appears on the LCD screen, and then press **Enter**.

If the carousel is full, the LCD screen displays `no slot free for transfer`. Press **Cancel** repeatedly until the main menu or Home screen is displayed.

Export a cartridge to make room for the firmware update cartridge (see "[Exporting Cartridges](#)"). Then return to step 1 to update the firmware.

If the carousel is not full, the autoloader will select the first available slot and prompt you to insert the code update cartridge.

3. Insert the code update cartridge into the media door.

 **NOTE:** If the cartridge is not a valid code update cartridge, the cartridge will be exported, and the LCD will display `Bad upgrade tape`.

During the firmware update, which can take several minutes, the LCD screen displays `CODE UPDATE IN PROGRESS`. When firmware update is complete, the autoloader resets and then unloads and exports the code update cartridge.

4. Remove the code update cartridge and press **Enter** when the LCD screen prompts you to do so.
5. If you exported a data cartridge to make room for the code update cartridge, be sure to import the cartridge to its original slot (see "[Importing Cartridges](#)").

 **NOTE:** After a firmware update, the firmware revision displayed on the LCD may not be updated until the autoloader is power cycled.

## Using SCSI

To obtain the files and instructions necessary to update drive and autoloader firmware via SCSI, go to [support.dell.com](http://support.dell.com) for details.

---

## Running the Autoloader System Test

The System Test option cycles the autoloader through the process of loading, calibrating, and unloading all cartridges in the carousel. Running a System Test verifies the operational soundness of both the autoloader and tape drive. The System Test continues indefinitely until you press **Cancel**. All regular backup or restore operations are suspended while a System Test is in progress.

To run a System Test:

 **NOTE:** At least one cartridge must be in the carousel before proceeding to run a System Test. If a cartridge is not present, import one before proceeding.

1. From the Home screen or main menu, press + or - until `Diagnostics` appears on the top line of the LCD screen, and then press **Enter**.
  2. When `System Test` is displayed, press **Enter** to begin the test.
  3. The `Test Count` displays the number of load-unload cycles that have been completed during the test.
  4. Press **Cancel** to end the test.
- 

## Retrieving Information About the Autoloader

The **Information** menu provides access to information about the autoloader, including the cycle count, event log, and firmware revision.

### Cycle Count

This option displays the total system cycle count, incrementing each time a tape is loaded into the drive or exported from the autoloader.

To use this option, follow these steps:

1. From the Home screen or main menu, press + or - until `Information` appears on the top line of the LCD screen, and then press **Enter** to access the available options.
2. Press + or - until `Cycle Count` appears on the LCD screen. The LCD screen displays the total cycle count.
3. Press **Cancel** when finished.

### View Event Log

This option provides access to the most recent autoloader errors and events (see "[Autoloader Error Codes](#)").

1. From the Home screen or main menu, press + or - until `Information` appears on the top line of the LCD screen, and then press **Enter** to access the available options.
2. Press + or - until `View Event Log` appears on the LCD screen.

The LCD screen also displays the quantity of errors and events currently stored in the event log.

3. Press **Enter** to access the most recently logged event.
4. Press + or - to display each event in the log.
5. Press **Cancel** when finished.

## Firmware Revision

This option displays the revision of the firmware currently installed in the autoloader.



**NOTE:** The tape drive and autoloader firmware are a single image, but the image may display as three firmware numbers on the front panel: Drive SCSI Controller, Robotics Controller Firmware, and Robotics SCSI Controller Firmware.

To use this option, follow these steps:

1. From the Home screen or main menu, press + or - until **Information** appears on the top line of the LCD screen, and then press **Enter** to access the available options.
2. Press + or - until **Firmware Rev** appears on the LCD screen.
3. The LCD screen displays the revision of the firmware currently installed in the autoloader.



**NOTE:** After a firmware update, the firmware revision displayed on the LCD will not be updated until the autoloader is power cycled.

4. Press **Cancel** when finished.

---

[Back to Contents Page](#)

[Back to Contents Page](#)

[Contacting Dell](#)

## Contacting Dell

To contact Dell electronically, you can access the following websites:

- 1 [www.dell.com](http://www.dell.com)
- 1 [support.dell.com](http://support.dell.com) (technical support)
- 1 [premiersupport.dell.com](http://premiersupport.dell.com) (technical support for educational, government, healthcare, and medium/large business customers, including Premier, Platinum, and Gold customers)

For specific web addresses for your country, find the appropriate country section in the table below.

**NOTE:** Toll-free numbers are for use within the country for which they are listed.

When you need to contact Dell, use the electronic addresses, telephone numbers, and codes provided in the following table. If you need assistance in determining which codes to use, contact a local or an international operator.

Country (City) International Access Code Country Code City Code	Department Name or Service Area, Website and E-Mail Address	Area Codes, Local Numbers, and Toll-Free Numbers
<b>Anguilla</b>	General Support	toll-free: 800-335-0031
<b>Antigua and Barbuda</b>	General Support	1-800-805-5924
<b>Argentina (Buenos Aires)</b>	Website: <a href="http://www.dell.com.ar">www.dell.com.ar</a>	
International Access Code: <b>00</b>	Tech Support and Customer Care	toll-free: 0-800-444-0733
Country Code: <b>54</b>	Sales	0-810-444-3355
City Code: <b>11</b>	Tech Support Fax	11 4515 7139
	Customer Care Fax	11 4515 7138
<b>Aruba</b>	General Support	toll-free: 800-1578
<b>Australia (Sydney)</b>	E-mail (Australia): <a href="mailto:au_tech_support@dell.com">au_tech_support@dell.com</a>	
International Access Code: <b>0011</b>	E-mail (New Zealand): <a href="mailto:nz_tech_support@dell.com">nz_tech_support@dell.com</a>	
Country Code: <b>61</b>	Home and Small Business	1-300-65-55-33
City Code: <b>2</b>	Government and Business	toll-free: 1-800-633-559
	Preferred Accounts Division (PAD)	toll-free: 1-800-060-889
	Customer Care	toll-free: 1-800-819-339
	Corporate Sales	toll-free: 1-800-808-385
	Transaction Sales	toll-free: 1-800-808-312
	Fax	toll-free: 1-800-818-341
<b>Austria (Vienna)</b>	Website: <a href="http://support.euro.dell.com">support.euro.dell.com</a>	
International Access Code: <b>900</b>	E-mail: <a href="mailto:tech_support_central_europe@dell.com">tech_support_central_europe@dell.com</a>	
Country Code: <b>43</b>	Home/Small Business Sales	0820 240 530 00
City Code: <b>1</b>	Home/Small Business Fax	0820 240 530 49
	Home/Small Business Customer Care	0820 240 530 14
	Preferred Accounts/Corporate Customer Care	0820 240 530 16
	Home/Small Business Technical Support	0820 240 530 14
	Preferred Accounts/Corporate Technical Support	0660 8779
	Switchboard	0820 240 530 00
<b>Bahamas</b>	General Support	toll-free: 1-866-278-6818

<b>Barbados</b>	General Support	1-800-534-3066
<b>Belgium (Brussels)</b>	Website: <a href="http://support.euro.dell.com">support.euro.dell.com</a>	
International Access Code: <b>00</b>	E-mail: <a href="mailto:tech_be@dell.com">tech_be@dell.com</a>	
Country Code: <b>32</b>	E-mail for French Speaking Customers: <a href="http://support.euro.dell.com/be/fr/emaildell/">support.euro.dell.com/be/fr/emaildell/</a>	
City Code: <b>2</b>	Technical Support	02 481 92 88
	Customer Care	02 481 91 19
	Corporate Sales	02 481 91 00
	Fax	02 481 92 99
	Switchboard	02 481 91 00
<b>Bermuda</b>	General Support	1-800-342-0671
<b>Bolivia</b>	General Support	toll-free: 800-10-0238
<b>Brazil</b>	Website: <a href="http://www.dell.com/br">www.dell.com/br</a>	
International Access Code: <b>00</b>	Customer Support, Technical Support	0800 90 3355
Country Code: <b>55</b>	Tech Support Fax	51 481 5470
City Code: <b>51</b>	Customer Care Fax	51 481 5480
	Sales	0800 90 3390
<b>British Virgin Islands</b>	General Support	toll-free: 1-866-278-6820
<b>Brunei</b>	Customer Technical Support (Penang, Malaysia)	604 633 4966
Country Code: <b>673</b>	Customer Service (Penang, Malaysia)	604 633 4949
	Transaction Sales (Penang, Malaysia)	604 633 4955
<b>Canada (North York, Ontario)</b>	Online Order Status: <a href="http://www.dell.ca/ostatus">www.dell.ca/ostatus</a>	
International Access Code: <b>011</b>	AutoTech (automated technical support)	toll-free: 1-800-247-9362
	TechFax	toll-free: 1-800-950-1329
	Customer Care (Home Sales/Small Business)	toll-free: 1-800-847-4096
	Customer Care (med./large business, government)	toll-free: 1-800-326-9463
	Technical Support (Home Sales/Small Business)	toll-free: 1-800-847-4096
	Technical Support (med./large bus., government)	toll-free: 1-800-387-5757
	Sales (Home Sales/Small Business)	toll-free: 1-800-387-5752
	Sales (med./large bus., government)	toll-free: 1-800-387-5755
	Spare Parts Sales & Extended Service Sales	1 866 440 3355
<b>Cayman Islands</b>	General Support	1-800-805-7541
<b>Chile (Santiago)</b>	Sales, Customer Support, and Technical Support	toll-free: 1230-020-4823
Country Code: <b>56</b>		
City Code: <b>2</b>		
<b>China (Xiamen)</b>	Tech Support website: <a href="http://support.dell.com.cn">support.dell.com.cn</a>	
Country Code: <b>86</b>		
City Code: <b>592</b>		
	Tech Support E-mail: <a href="mailto:cn_support@dell.com">cn_support@dell.com</a>	
	Tech Support Fax	818 1350
	Technical Support (Dimension™ and Inspiron™)	toll-free: 800 858 2969
	Technical Support (OptiPlex™, Latitude™, and Dell Precision™)	toll-free: 800 858 0950
	Technical Support (servers and storage)	toll-free: 800 858 0960
	Tech Support (projectors, PDAs, printers, switches, routers, and so on)	toll-free: 800 858 2920
	Customer Experience	toll-free: 800 858 2060
	Home and Small Business	toll-free: 800 858 2222
	Preferred Accounts Division	toll-free: 800 858 2557
	Large Corporate Accounts GCP	toll-free: 800 858 2055
	Large Corporate Accounts Key Accounts	toll-free: 800 858 2628
	Large Corporate Accounts North	toll-free: 800 858 2999
	Large Corporate Accounts North Government and Education	toll-free: 800 858 2955

	Large Corporate Accounts East	toll-free: 800 858 2020
	Large Corporate Accounts East Government and Education	toll-free: 800 858 2669
	Large Corporate Accounts Queue Team	toll-free: 800 858 2222
	Large Corporate Accounts South	toll-free: 800 858 2355
	Large Corporate Accounts West	toll-free: 800 858 2811
	Large Corporate Accounts Spare Parts	toll-free: 800 858 2621
<b>Colombia</b>	General Support	980-9-15-3978
<b>Costa Rica</b>	General Support	0800-012-0435
<b>Czech Republic (Prague)</b>	Website: <a href="http://support.euro.dell.com">support.euro.dell.com</a>	
International Access Code: <b>00</b>	E-mail: <a href="mailto:czech_dell@dell.com">czech_dell@dell.com</a>	
Country Code: <b>420</b>	Technical Support	02 2186 27 27
City Code: <b>2</b>	Customer Care	02 2186 27 11
	Fax	02 2186 27 14
	TechFax	02 2186 27 28
	Switchboard	02 2186 27 11
<b>Denmark (Copenhagen)</b>	Website: <a href="http://support.euro.dell.com">support.euro.dell.com</a>	
International Access Code: <b>00</b>	E-mail Support (portable computers): <a href="mailto:den_nbk_support@dell.com">den_nbk_support@dell.com</a>	
Country Code: <b>45</b>	E-mail Support (desktop computers): <a href="mailto:den_support@dell.com">den_support@dell.com</a>	
	E-mail Support (servers): <a href="mailto:Nordic_server_support@dell.com">Nordic_server_support@dell.com</a>	
	Technical Support	7023 0182
	Customer Care (Relational)	7023 0184
	Home/Small Business Customer Care	3287 5505
	Switchboard (Relational)	3287 1200
	Fax Switchboard (Relational)	3287 1201
	Switchboard (Home/Small Business)	3287 5000
	Fax Switchboard (Home/Small Business)	3287 5001
<b>Dominica</b>	General Support	toll-free: 1-866-278-6821
<b>Dominican Republic</b>	General Support	1-800-148-0530
<b>Ecuador</b>	General Support	toll-free: 999-119
<b>El Salvador</b>	General Support	01-899-753-0777
<b>Finland (Helsinki)</b>	Website: <a href="http://support.euro.dell.com">support.euro.dell.com</a>	
International Access Code: <b>990</b>	E-mail: <a href="mailto:fin_support@dell.com">fin_support@dell.com</a>	
Country Code: <b>358</b>	E-mail Support (servers): <a href="mailto:Nordic_support@dell.com">Nordic_support@dell.com</a>	
City Code: <b>9</b>	Technical Support	09 253 313 60
	Technical Support Fax	09 253 313 81
	Relational Customer Care	09 253 313 38
	Home/Small Business Customer Care	09 693 791 94
	Fax	09 253 313 99
	Switchboard	09 253 313 00
<b>France (Paris) (Montpellier)</b>	Website: <a href="http://support.euro.dell.com">support.euro.dell.com</a>	
International Access Code: <b>00</b>	E-mail: <a href="http://support.euro.dell.com/fr/fr/emaildell/">support.euro.dell.com/fr/fr/emaildell/</a>	
Country Code: <b>33</b>	<b>Home and Small Business</b>	
City Codes: <b>(1) (4)</b>	Technical Support	0825 387 270
	Customer Care	0825 823 833
	Switchboard	0825 004 700
	Switchboard (calls from outside of France)	04 99 75 40 00
	Sales	0825 004 700
	Fax	0825 004 701
	Fax (calls from outside of France)	04 99 75 40 01
	<b>Corporate</b>	
	Technical Support	0825 004 719



	Customer Care	0825 338 339
	Switchboard	01 55 94 71 00
	Sales	01 55 94 71 00
	Fax	01 55 94 71 01
<b>Germany (Langen)</b>	Website: <a href="http://support.euro.dell.com">support.euro.dell.com</a>	
International Access Code: <b>00</b>	E-mail: <a href="mailto:tech_support_central_europe@dell.com">tech_support_central_europe@dell.com</a>	
Country Code: <b>49</b>	Technical Support	06103 766-7200
City Code: <b>6103</b>	Home/Small Business Customer Care	0180-5-224400
	Global Segment Customer Care	06103 766-9570
	Preferred Accounts Customer Care	06103 766-9420
	Large Accounts Customer Care	06103 766-9560
	Public Accounts Customer Care	06103 766-9555
	Switchboard	06103 766-7000
<b>Greece</b>	Website: <a href="http://support.euro.dell.com">support.euro.dell.com</a>	
International Access Code: <b>00</b>	E-mail: <a href="mailto:support.euro.dell.com/gr/en/emaildell/">support.euro.dell.com/gr/en/emaildell/</a>	
Country Code: <b>30</b>	Technical Support	080044149518
	Gold Technical Support	08844140083
	Switchboard	2108129800
	Sales	2108129800
	Fax	2108129812
<b>Grenada</b>	General Support	toll-free: 1-866-540-3355
<b>Guatemala</b>	General Support	1-800-999-0136
<b>Guyana</b>	General Support	toll-free: 1-877-270-4609
<b>Hong Kong</b>	Website: <a href="http://support.ap.dell.com">support.ap.dell.com</a>	
International Access Code: <b>001</b>	E-mail: <a href="mailto:ap_support@dell.com">ap_support@dell.com</a>	
Country Code: <b>852</b>	Technical Support (Dimension™ and Inspiron™)	2969 3189
	Technical Support (OptiPlex™, Latitude™, and Dell Precision™)	2969 3191
	Technical Support (PowerApp™, PowerEdge™, PowerConnect™, and PowerVault™)	2969 3196
	Gold Queue EEC Hotline	2969 3187
	Customer Advocacy	3416 0910
	Large Corporate Accounts	3416 0907
	Global Customer Programs	3416 0908
	Medium Business Division	3416 0912
	Home and Small Business Division	2969 3105
<b>India</b>	Technical Support	1600 33 8045
	Sales	1600 33 8044
<b>Ireland (Cherrywood)</b>	Website: <a href="http://support.euro.dell.com">support.euro.dell.com</a>	
International Access Code: <b>16</b>	E-mail: <a href="mailto:dell_direct_support@dell.com">dell_direct_support@dell.com</a>	
Country Code: <b>353</b>	Technical Support	1850 543 543
City Code: <b>1</b>	U.K. Technical Support (dial within U.K. only)	0870 908 0800
	Home User Customer Care	01 204 4014
	Small Business Customer Care	01 204 4014
	U.K. Customer Care (dial within U.K. only)	0870 906 0010
	Corporate Customer Care	1850 200 982
	Corporate Customer Care (dial within U.K. only)	0870 907 4499
	Ireland Sales	01 204 4444
	U.K. Sales (dial within U.K. only)	0870 907 4000
	Fax/SalesFax	01 204 0103
	Switchboard	01 204 4444

<b>Italy (Milan)</b>	Website: <a href="http://support.euro.dell.com">support.euro.dell.com</a>		
International Access Code: <b>00</b>	E-mail: <a href="mailto:support.euro.dell.com/it/it/emaildell/">support.euro.dell.com/it/it/emaildell/</a>		
Country Code: <b>39</b>	<b>Home and Small Business</b>		
City Code: <b>02</b>	Technical Support	02 577 826 90	
	Customer Care	02 696 821 14	
	Fax	02 696 821 13	
	Switchboard	02 696 821 12	
	<b>Corporate</b>		
	Technical Support	02 577 826 90	
	Customer Care	02 577 825 55	
	Fax	02 575 035 30	
	Switchboard	02 577 821	
<b>Jamaica</b>	General Support (dial from within Jamaica only)	1-800-682-3639	
<b>Japan (Kawasaki)</b>	Website: <a href="http://support.jp.dell.com">support.jp.dell.com</a>		
International Access Code: <b>001</b>	Technical Support (servers)	toll-free: 0120-198-498	
	Technical Support outside of Japan (servers)	81-44-556-4162	
	Country Code: <b>81</b>	<b>Technical Support (Dimension™ and Inspiron™)</b>	toll-free: 0120-198-226
	City Code: <b>44</b>	Technical Support outside of Japan (Dimension and Inspiron)	81-44-520-1435
		<b>Technical Support (Dell Precision™, OptiPlex™, and Latitude™)</b>	toll-free: 0120-198-433
		Technical Support outside of Japan (Dell Precision, OptiPlex, and Latitude)	81-44-556-3894
		<b>Technical Support (Axim™)</b>	toll-free: 0120-981-690
		Technical Support outside of Japan (Axim)	81-44-556-3468
		Faxbox Service	044-556-3490
		24-Hour Automated Order Service	044-556-3801
		Customer Care	044-556-4240
		Business Sales Division (up to 400 employees)	044-556-1465
		Preferred Accounts Division Sales (over 400 employees)	044-556-3433
		Large Corporate Accounts Sales (over 3500 employees)	044-556-3430
		Public Sales (government agencies, educational institutions, and medical institutions)	044-556-1469
		Global Segment Japan	044-556-3469
		Individual User	044-556-1760
		Switchboard	044-556-4300
		<b>Korea (Seoul)</b>	Technical Support
International Access Code: <b>001</b>		Sales	toll-free: 080-200-3600
	Country Code: <b>82</b>	Customer Service (Seoul, Korea)	toll-free: 080-200-3800
	City Code: <b>2</b>	Customer Service (Penang, Malaysia)	604 633 4949
		Fax	2194-6202
		Switchboard	2194-6000
<b>Latin America</b>	Customer Technical Support (Austin, Texas, U.S.A.)	512 728-4093	
	Customer Service (Austin, Texas, U.S.A.)	512 728-3619	
	Fax (Technical Support and Customer Service) (Austin, Texas, U.S.A.)	512 728-3883	
	Sales (Austin, Texas, U.S.A.)	512 728-4397	
	SalesFax (Austin, Texas, U.S.A.)	512 728-4600 or 512 728-3772	
<b>Luxembourg</b>	Website: <a href="http://support.euro.dell.com">support.euro.dell.com</a>		
International Access Code: <b>00</b>	E-mail: <a href="mailto:tech_be@dell.com">tech_be@dell.com</a>		
	Country Code: <b>352</b>	Technical Support (Brussels, Belgium)	3420808075
		Home/Small Business Sales (Brussels, Belgium)	toll-free: 080016884

	Corporate Sales (Brussels, Belgium)	02 481 91 00
	Customer Care (Brussels, Belgium)	02 481 91 19
	Fax (Brussels, Belgium)	02 481 92 99
	Switchboard (Brussels, Belgium)	02 481 91 00
<b>Macao</b>	Technical Support	toll-free: 0800 582
Country Code: <b>853</b>	Customer Service (Penang, Malaysia)	604 633 4949
	Transaction Sales	toll-free: 0800 581
<b>Malaysia (Penang)</b>	Technical Support	toll-free: 1 800 888 298
International Access Code: <b>00</b>	Customer Service	04 633 4949
Country Code: <b>60</b>	Transaction Sales	toll-free: 1 800 888 202
City Code: <b>4</b>	Corporate Sales	toll-free: 1 800 888 213
<b>Mexico</b>	Customer Technical Support	001-877-384-8979 or 001-877-269-3383
International Access Code: <b>00</b>	Sales	50-81-8800 or 01-800-888-3355
Country Code: <b>52</b>	Customer Service	001-877-384-8979 or 001-877-269-3383
	Main	50-81-8800 or 01-800-888-3355
<b>Montserrat</b>	General Support	toll-free: 1-866-278-6822
<b>Netherlands Antilles</b>	General Support	001-800-882-1519
<b>Netherlands (Amsterdam)</b>	Website: <a href="http://support.euro.dell.com">support.euro.dell.com</a>	
International Access Code: <b>00</b>	E-mail (Technical Support):	
Country Code: <b>31</b>	(Enterprise): nl_server_support@dell.com	
City Code: <b>20</b>	(Latitude): nl_latitude_support@dell.com	
	(Inspiron): nl_inspiron_support@dell.com	
	(Dimension): nl_dimension_support@dell.com	
	(OptiPlex): nl_optiplex_support@dell.com	
	(Dell Precision): nl_workstation_support@dell.com	
	Technical Support	020 674 45 00
	Technical Support Fax	020 674 47 66
	Home/Small Business Customer Care	020 674 42 00
	Relational Customer Care	020 674 4325
	Home/Small Business Sales	020 674 55 00
	Relational Sales	020 674 50 00
	Home/Small Business Sales Fax	020 674 47 75
	Relational Sales Fax	020 674 47 50
	Switchboard	020 674 50 00
	Switchboard Fax	020 674 47 50
<b>New Zealand</b>	E-mail (New Zealand): nz_tech_support@dell.com	
International Access Code: <b>00</b>	E-mail (Australia): au_tech_support@dell.com	
Country Code: <b>64</b>	Home and Small Business	0800 446 255
	Government and Business	0800 444 617
	Sales	0800 441 567
	Fax	0800 441 566

<b>Nicaragua</b>	General Support	001-800-220-1006
<b>Norway (Lysaker)</b>	Website: <a href="http://support.euro.dell.com">support.euro.dell.com</a>	
International Access Code: <b>00</b>	E-mail Support (portable computers): nor_nbk_support@dell.com	
Country Code: <b>47</b>	E-mail Support (desktop computers): nor_support@dell.com	
	E-mail Support (servers): nordic_server_support@dell.com	
	Technical Support	671 16882
	Relational Customer Care	671 17514
	Home/Small Business Customer Care	23162298
	Switchboard	671 16800
	Fax Switchboard	671 16865
<b>Panama</b>	General Support	001-800-507-0962
<b>Peru</b>	General Support	0800-50-669
<b>Poland (Warsaw)</b>	Website: <a href="http://support.euro.dell.com">support.euro.dell.com</a>	
International Access Code: <b>011</b>	E-mail: pl_support_tech@dell.com	
Country Code: <b>48</b>	Customer Service Phone	57 95 700
City Code: <b>22</b>	Customer Care	57 95 999
	Sales	57 95 999
	Customer Service Fax	57 95 806
	Reception Desk Fax	57 95 998
	Switchboard	57 95 999
<b>Portugal</b>	Website: <a href="http://support.euro.dell.com">support.euro.dell.com</a>	
International Access Code: <b>00</b>	E-mail: <a href="mailto:support.euro.dell.com/pt/en/emaiddell/">support.euro.dell.com/pt/en/emaiddell/</a>	
Country Code: <b>351</b>	Technical Support	707200149
	Customer Care	800 300 413
	Sales	800 300 410 or 800 300 411 or 800 300 412 or 21 422 07 10
	Fax	21 424 01 12
<b>Puerto Rico</b>	General Support	1-800-805-7545
<b>St. Kitts and Nevis</b>	General Support	toll-free: 1-877-441-4731
<b>St. Lucia</b>	General Support	1-800-882-1521
<b>St. Vincent and the Grenadines</b>	General Support	toll-free: 1-877-270-4609
<b>Singapore (Singapore)</b>	Technical Support	toll-free: 800 6011 051
International Access Code: <b>005</b>	Customer Service (Penang, Malaysia)	604 633 4949
Country Code: <b>65</b>	Transaction Sales	toll-free: 800 6011 054
	Corporate Sales	toll-free: 800 6011 053
<b>South Africa (Johannesburg)</b>	Website: <a href="http://support.euro.dell.com">support.euro.dell.com</a>	
International Access Code: <b>09/091</b>	E-mail: dell_za_support@dell.com	
Country Code: <b>27</b>	Technical Support	011 709 7710
City Code: <b>11</b>	Customer Care	011 709 7707
	Sales	011 709 7700
	Fax	011 706 0495
	Switchboard	011 709 7700
<b>Southeast Asian and Pacific Countries</b>	Customer Technical Support, Customer Service, and Sales (Penang, Malaysia)	604 633 4810
<b>Spain (Madrid)</b>	Website: <a href="http://support.euro.dell.com">support.euro.dell.com</a>	
International Access Code: <b>00</b>	E-mail: <a href="mailto:support.euro.dell.com/es/es/emaiddell/">support.euro.dell.com/es/es/emaiddell/</a>	

Country Code: <b>34</b> City Code: <b>91</b>	<b>Home and Small Business</b>	
	Technical Support	902 100 130
	Customer Care	902 118 540
	Sales	902 118 541
	Switchboard	902 118 541
	Fax	902 118 539
	<b>Corporate</b>	
	Technical Support	902 100 130
	Customer Care	902 118 546
	Switchboard	91 722 92 00
Fax	91 722 95 83	
<b>Sweden (Upplands Vasby)</b>	Website: <a href="http://support.euro.dell.com">support.euro.dell.com</a>	
International Access Code: <b>00</b> Country Code: <b>46</b> City Code: <b>8</b>	E-mail: <a href="mailto:swe_support@dell.com">swe_support@dell.com</a>	
	E-mail Support for Latitude and Inspiron: <a href="mailto:Swe-nbk_kats@dell.com">Swe-nbk_kats@dell.com</a>	
	E-mail Support for OptiPlex: <a href="mailto:Swe_kats@dell.com">Swe_kats@dell.com</a>	
	E-mail Support for Servers: <a href="mailto:Nordic_server_support@dell.com">Nordic_server_support@dell.com</a>	
	Technical Support	08 590 05 199
	Relational Customer Care	08 590 05 642
	Home/Small Business Customer Care	08 587 70 527
	Employee Purchase Program (EPP) Support	20 140 14 44
	Fax Technical Support	08 590 05 594
	Sales	08 590 05 185
<b>Switzerland (Geneva)</b>	Website: <a href="http://support.euro.dell.com">support.euro.dell.com</a>	
International Access Code: <b>00</b> Country Code: <b>41</b> City Code: <b>22</b>	E-mail: <a href="mailto:swisstech@dell.com">swisstech@dell.com</a>	
	E-mail for French-speaking HSB and Corporate Customers: <a href="http://support.euro.dell.com/ch/fr/emaildell/">support.euro.dell.com/ch/fr/emaildell/</a>	
	Technical Support (Home and Small Business)	0844 811 411
	Technical Support (Corporate)	0844 822 844
	Customer Care (Home and Small Business)	0848 802 202
	Customer Care (Corporate)	0848 821 721
	Fax	022 799 01 90
	Switchboard	022 799 01 01
<b>Taiwan</b>	Technical Support (portable and desktop computers)	toll-free: 00801 86 1011
International Access Code: <b>002</b> Country Code: <b>886</b>	Technical Support (servers)	toll-free: 0080 60 1256
	Transaction Sales	toll-free: 0080 651 228
	Corporate Sales	toll-free: 0080 651 227
<b>Thailand</b>	Technical Support	toll-free: 0880 060 07
International Access Code: <b>001</b> Country Code: <b>66</b>	Customer Service (Penang, Malaysia)	604 633 4949
	Sales	toll-free: 0880 060 09
<b>Trinidad/Tobago</b>	General Support	1-800-805-8035
<b>Turks and Caicos Islands</b>	General Support	toll-free: 1-866-540-3355
<b>U.K. (Bracknell)</b>	Website: <a href="http://support.euro.dell.com">support.euro.dell.com</a>	
International Access Code: <b>00</b> Country Code: <b>44</b> City Code: <b>1344</b>	Customer Care website: <a href="http://support.euro.dell.com/uk/en/ECare/Form/Home.asp">support.euro.dell.com/uk/en/ECare/Form/Home.asp</a>	
	E-mail: <a href="mailto:dell_direct_support@dell.com">dell_direct_support@dell.com</a>	
	Technical Support (Corporate/Preferred Accounts/PAD [1000+ employees])	0870 908 0500
	Technical Support (direct/PAD and general)	0870 908 0800
	Global Accounts Customer Care	01344 373 186

	Home and Small Business Customer Care	0870 906 0010
	Corporate Customer Care	01344 373 185
	Preferred Accounts (500 5000 employees) Customer Care	0870 906 0010
	Central Government Customer Care	01344 373 193
	Local Government & Education Customer Care	01344 373 199
	Health Customer Care	01344 373 194
	Home and Small Business Sales	0870 907 4000
	Corporate/Public Sector Sales	01344 860 456
	Home and Small Business Fax	0870 907 4006
<b>Uruguay</b>	General Support	toll-free: 000-413-598-2521
<b>U.S.A. (Austin, Texas)</b>  International Access Code: <b>011</b>  Country Code: <b>1</b>	Automated Order-Status Service	toll-free: 1-800-433-9014
	AutoTech (portable and desktop computers)	toll-free: 1-800-247-9362
	<b>Consumer (Home and Home Office)</b>	
	Technical Support	toll-free: 1-800-624-9896
	Customer Service	toll-free: 1-800-624-9897
	<b>DellNet™ Service and Support</b>	toll-free: 1-877-Dellnet (1-877-335-5638)
	Employee Purchase Program (EPP) Customers	toll-free: 1-800-695-8133
	Financial Services website: <a href="http://www.dellfinancialservices.com">www.dellfinancialservices.com</a>	
	Financial Services (lease/loans)	toll-free: 1-877-577-3355
	Financial Services (Dell Preferred Accounts [DPA])	toll-free: 1-800-283-2210
	<b>Business</b>	
	Customer Service and Technical Support	toll-free: 1-800-822-8965
	Employee Purchase Program (EPP) Customers	toll-free: 1-800-695-8133
	Printers and Projectors Technical Support	toll-free: 1-877-459-7298
	<b>Public (government, education, and healthcare)</b>	
	Customer Service and Technical Support	toll-free: 1-800-456-3355
	Employee Purchase Program (EPP) Customers	toll-free: 1-800-234-1490
	Dell Sales	toll-free: 1-800-289-3355 or toll-free: 1-800-879-3355
	Dell Outlet Store (Dell refurbished computers)	toll-free: 1-888-798-7561
	Software and Peripherals Sales	toll-free: 1-800-671-3355
Spare Parts Sales	toll-free: 1-800-357-3355	
Extended Service and Warranty Sales	toll-free: 1-800-247-4618	
Fax	toll-free: 1-800-727-8320	
Dell Services for the Deaf, Hard-of-Hearing, or Speech-Impaired	toll-free: 1-877-DELLTTY (1-877-335-5889)	
<b>U.S. Virgin Islands</b>	General Support	1-877-673-3355
<b>Venezuela</b>	General Support	8001-3605

## Diagnostics and Troubleshooting: Dell™ PowerVault™ 122T DLT VS80 Autoloader User's Guide

- [Troubleshooting](#)
  - [Removing Lodged Cartridges](#)
  - [Autoloader Error Codes](#)
- 

### Troubleshooting

#### Installation Problems

Problems encountered during the installation of the autoloader are usually caused by improper SCSI bus configuration, application software configuration errors, or by an incorrectly configured operating system. If the application software that you are using is not communicating with the autoloader after installation, check the following:

- 1 **SCSI ID:** The autoloader uses one SCSI ID and two Logical Unit Numbers (LUNs): one LUN for the tape drive (0) and one for the autoloader robotics (1). Depending on other devices attached to the same SCSI bus and their SCSI IDs, you may need to change the SCSI ID of the autoloader before you can use the autoloader. Select an unused SCSI ID. See the manuals for the other devices on the SCSI bus or your operating system to determine which SCSI IDs are currently in use. If the autoloader is attached to a narrow (50-pin) SCSI bus (not recommended), only SCSI IDs 0 through 7 are available (see "[Changing the SCSI ID](#)").
- 1 **SCSI Cabling:** Verify that all SCSI cables are securely connected at both ends. Check the length and integrity of your SCSI cabling. The total length of all cables connected to a SCSI bus must not exceed 6 m (19 ft) for a SCSI-1 Single Ended (SE) bus, 3 m (10 ft) for a Fast SCSI (Narrow or Wide) or an Ultra SCSI (Narrow or Wide) SE bus, 12 m (40 ft) for an Low Voltage Differential (LVD) bus with multiple devices, or 25 m (82 ft) for an LVD bus with a single device. The length of the internal SCSI cabling inside the autoloader is 30 cm (1 ft). This length must be included in any calculations of cable length. Try replacing suspect cables with known good cables. Note that it is not recommended to connect the autoloader to a narrow (50-pin) or SE SCSI bus as performance will be restricted.
- 1 **Termination:** If the autoloader is the only SCSI device—other than the SCSI host adapter—on the selected SCSI bus, it must be terminated. Likewise, if the autoloader is physically the last SCSI device on the SCSI bus, it must be terminated. Only the devices physically at the beginning and end of the SCSI bus should be terminated. Refer to the manuals supplied with other devices on the SCSI bus for information on enabling or disabling termination on those devices.  
  
To terminate the autoloader, locate the terminator in the accessories package and press it firmly into either of the two SCSI connectors on the back panel of the autoloader. Secure the terminator by tightening the finger-screws until snug. The supplied terminator is "dual mode" and will work on both LVD and SE (SE is not recommended) SCSI buses. A green LED on the terminator indicates that the unit is attached to a SCSI bus running in LVD mode. A red LED on the terminator indicates that the unit is attached to a SCSI bus running in SE mode. If the LED is not on, check all SCSI and power connections and confirm that the unit is attached to a valid SCSI bus.
- 1 **Compatibility:** Ensure that the autoloader is compatible with the SCSI host adapter and backup application you plan to use. For a list of compatible SCSI adapters and application software, check with your SCSI host adapter manufacturer, backup application vendor, or the Dell Support website at [support.dell.com](http://support.dell.com).
- 1 **SCSI Host Adapter Installation:** Verify that you have installed your SCSI host adapter correctly. Refer to the manual that came with your SCSI host adapter for installation and troubleshooting instructions. Pay particular attention to any steps describing the settings of various jumpers and/or switches on the host adapter, or on newer adapters, the setup application for the adapter. Make sure that the host adapter is properly seated in the system board slot and the operating system correctly detects the host adapter. Make sure that the proper device driver is installed for the SCSI host adapter.
- 1 **Backup Application Installation:** Refer to the documentation included with your backup application for instructions on how to verify proper installation. Most backup software packages require an additional module to communicate with the autoloader robotics.
- 1 **Device Driver Installation:** Make sure that the proper device driver, if applicable, is installed for the autoloader (see "[Installing the Device Drivers](#)"). Also refer to "[Contacting Dell](#)" for more information.



**NOTE:** Many backup applications use their own drivers for the autoloader and drive. Before installing a driver, make sure it will not be in conflict with the software.

#### Troubleshooting Table

Problem	Solution
<b>Power</b> Autoloader does not power on.	<ol style="list-style-type: none"><li>1 Check all power cable connections.</li><li>1 Make sure the power switch on the front panel is in the ON position.</li><li>1 Make sure there is power to the outlet. Try another working outlet.</li><li>1 Replace the power cable.</li><li>1 <a href="#">Contact</a> your service representative.</li></ol>
No display messages appear.	<ol style="list-style-type: none"><li>1 Make sure the power cable is connected.</li><li>1 Make sure the power switch is on.</li><li>1 Power cycle the autoloader.</li><li>1 Download autoloader firmware.</li><li>1 <a href="#">Contact</a> your service representative.</li></ol>
<b>Tape Movement</b> Tape lodged in drive.	<ol style="list-style-type: none"><li>1 Power cycle the autoloader, allow it to complete initialization, and then retry unloading the tape using the</li></ol>

	<ul style="list-style-type: none"> <li>autoloader Operator Panel controls.</li> <li>1 Allow the tape drive to complete all operations, and then try unloading the tape using the autoloader Operator's Panel controls.</li> <li>1 Make sure that the backup software is not reserving the slot or preventing the tape drive from ejecting the cartridge. The backup software needs to cancel the reservation and any hold it has on the tape drive. Temporarily disconnecting the autoloader from the host server eliminates the host and its software as a problem source.</li> <li>1 <a href="#">Contact</a> your service representative.</li> </ul>
Tape lodged in storage slot.	<ul style="list-style-type: none"> <li>1 See "<a href="#">Removing Lodged Cartridges</a>".</li> </ul>
<b>Media</b>	
Cleaning or data cartridge incompatible with drive.	<ul style="list-style-type: none"> <li>1 Make sure you are using cleaning and data cartridges that are compatible with the drive. The autoloader automatically unloads incompatible cartridges to their original slots.</li> </ul>
Cannot write to or read from a tape.	<ul style="list-style-type: none"> <li>1 Make sure that the cartridge is write enabled (see "<a href="#">Write-protecting Cartridges</a>").</li> <li>1 Make sure that the cartridge is a DLTapeIV that has not been written using an incompatible format. The drive can read, but not write, a DLT4000 formatted tape.</li> <li>1 Make sure that the cartridge has not been exposed to harsh environmental or electrical conditions and is not physically damaged in any way.</li> <li>1 Many backup applications do not read or write to cartridges that were created using a different backup application. In this case, you may have to perform an erase, format, or label operation on the cartridge.</li> <li>1 Make sure you understand any data protection or overwrite protection schemes that your backup application may be using, which could prevent you from writing to a given cartridge.</li> <li>1 Retry the operation with a different, known good tape.</li> <li>1 Clean the tape drive (see "<a href="#">Cleaning the Tape Drive</a>").</li> </ul>
<b>SCSI ID</b>	
Changed drive SCSI ID, but the host server does not recognize the new ID.	<ul style="list-style-type: none"> <li>1 Make sure that all SCSI devices on the same bus have unique ID numbers.</li> <li>1 If the SCSI bus is narrow (50-pin), only SCSI IDs 0 through 7 are available.</li> <li>1 Make sure that you cycle power on the autoloader after changing the SCSI ID.</li> <li>1 Reboot the host server.</li> </ul>
<b>Autoloader Performance</b>	
The autoloader is not efficiently backing up data.	<ul style="list-style-type: none"> <li>1 Check the network bandwidth from the host computer. If you are backing up data over a network, consider comparing to a local-only backup.</li> <li>1 Make sure that the autoloader is on its own SCSI bus and not daisy-chained to another tape drive or to the hard drive being backed up.</li> <li>1 Clean the tape drive (see "<a href="#">Cleaning the Tape Drive</a>").</li> <li>1 Try a new cartridge. A marginal cartridge can cause performance problems due to bad spots on the tape requiring retries.</li> <li>1 Make sure that the data is being compressed.</li> <li>1 Check the size of the files. Small file size can impact performance.</li> <li>1 Confirm that the backup application is utilizing block sizes of at least 32 KB, preferably 64 KB. Refer to your application's documentation for details.</li> </ul>
<b>Cleaning</b>	
Recurring cleaning message.	<ul style="list-style-type: none"> <li>1 Make sure you are using a DLT1 compatible cleaning cartridge.</li> <li>1 Replace the existing cleaning cartridge with a new one.</li> <li>1 If the Media Attention LED is cleared using a cleaning cartridge and then immediately reappears after a particular data cartridge is reloaded, that data cartridge might be contaminated. If this occurs, check that the data cartridge can be read, back up data from the suspect cartridge to another cartridge, and then discard the suspect cartridge.</li> </ul>
The <b>Clean Drive</b> LED is illuminated.	<ul style="list-style-type: none"> <li>1 Indicates that 250 tape motion hours have passed since you last cleaned the tape drive.</li> <li>1 Clean the tape drive (see "<a href="#">Cleaning the Tape Drive</a>").</li> </ul>
Cannot load the cleaning cartridge.	<ul style="list-style-type: none"> <li>1 Make sure you are using a DLT1 compatible cleaning cartridge (see "<a href="#">Cleaning the Tape Drive</a>").</li> <li>1 <a href="#">Contact</a> your service representative.</li> </ul>
<b>Media Compatibility</b>	
Media format invalid for drive type.	<ul style="list-style-type: none"> <li>1 You attempted to load incompatible media into the tape drive. Ensure your media and format is compatible with a DLT VS80 tape drive (see "<a href="#">Using Cartridges</a>").</li> </ul>
Media is labeled as write protected by the host server, but restore from tape successful.	<ul style="list-style-type: none"> <li>1 Media with the DLT4000 format was loaded into the tape drive. The data is readable, but the media must be bulk-erased before the tape drive can write to this cartridge.</li> </ul>
Media is rejected by the tape drive. Restore from tape NOT successful.	<ul style="list-style-type: none"> <li>1 You attempted to load damaged or incompatible media or the tape drives' read/write head is dirty. Try replacing the cartridge or cleaning the drive.</li> </ul>
<b>Media Attention LED Issues</b>	
Contamination by loose debris.	<ul style="list-style-type: none"> <li>1 Avoid contamination by ensuring that the autoloader is installed in a clean, contamination-free environment. Cartridges should be stored vertically in their plastic cases. Continue cleaning the tape drive as requested.</li> </ul>
Contamination by head staining. (caused by adhesion of chemicals that are present in the tape media to the head surface)	<ul style="list-style-type: none"> <li>1 One or two passes with a cleaning cartridge should resolve the Media Attention LED caused by normal head staining. If a cleaning cartridge is unsuccessful in resolving a cleaning light after three or more attempts, <a href="#">contact</a> your service representative.</li> </ul>
Non-acclimated media	<ul style="list-style-type: none"> <li>1 A cartridge should be acclimated for a minimum of 24 hours before being used, particularly if it has been stored at a substantially different temperature or level of humidity than the tape library.</li> </ul>
Wrong cleaning cartridge	<ul style="list-style-type: none"> <li>1 Make sure you are using a DLT1 compatible cleaning cartridge.</li> </ul>
Bad/defective/contaminated media	<ul style="list-style-type: none"> <li>1 If the Media Attention LED is cleared using a cleaning cartridge and then immediately reappears each time a particular cartridge is reloaded, and you have confirmed that the suspect cartridge is not invalid, that cartridge should be suspected as being contaminated. If this occurs, export the cartridge, clean the tape drive again, and then load a known good cartridge. In some cases, a cartridge can be worn out, have bad calibration tracks, have been improperly degaussed, or have a bad tape directory recorded by another drive type such as DLT7000 or DLT8000.</li> </ul>



Expired cleaning cartridge 1 A cleaning cartridge is good for 20 uses. Use a newer cleaning cartridge.

#### Errors Displayed on Front Panel

"!" in autoloader operator panel inventory display

1 An exclamation point (!) displayed in the inventory indicates that the autoloader has identified a cartridge in the indicated slot that is either an invalid cartridge type or has had a media error. The Media Attention LED is also illuminated in this case (see "[LED Indicators](#)"). Exporting the indicated cartridge will clear the error condition (see "[Exporting Cartridges](#)"). If these symptoms occur on multiple known good cartridges, consider cleaning the tape drive (see "[Cleaning the Tape Drive](#)"). If a particular cartridge causes these symptoms repeatedly, that cartridge may be defective or invalid.

There is an error code on the LCD screen

1 Look up the error code, try to resolve the failure, and power cycle (see "[Autoloader Error Codes](#)").



**NOTE:** If you experience failures with reused DLT formatted (degaussed) cartridges, the degaussing may not have been sufficient to fully erase the data. If this happens, use another cartridge, preferably a new, unformatted DLTapeIV cartridge, before suspecting other system components.

---

## Removing Lodged Cartridges

If the autoloader experiences a severe mechanical problem or if you need to remove cartridges because of a power failure or other circumstance in which the autoloader is unable to export the cartridges in the carousel, follow these steps:



**NOTE:** [Contact](#) your Dell support representative if a cartridge is lodged in the drive.

1. Move the power switch on the front panel to the OFF position.
2. Remove the power cable and SCSI cables from their connectors on the back panel of the autoloader.



**CAUTION:** To prevent injury, disconnect the power and SCSI cables before removing the autoloader cover and keep fingers away from the fan.

3. Remove the autoloader from its rack slot, if applicable, and place it on a table or other clean and level work surface.
4. In a rackmounted unit, use a screwdriver to remove the front cover screws that secure the mounting brackets from both sides of the autoloader. In a table top unit, remove the front cover screws—there are no mounting brackets.

#### Removing Mounting Brackets (Left Side Shown)

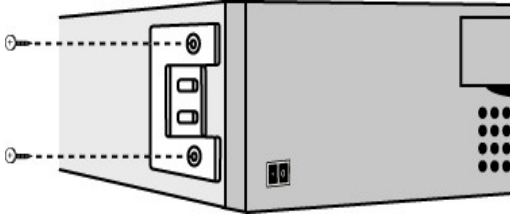

5. If the autoloader has mounting brackets (rackmount unit), remove the five screws on the back of the autoloader, and two additional screws, one on each side of the autoloader, to loosen the autoloader cover. In a table top unit, remove the front cover screws and three additional screws from each side of the unit.

#### Remove Indicated Back Cover Screws Only

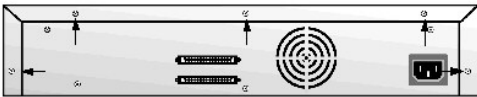

6. Slide the top cover towards the back before attempting to lift the cover.
7. After the top cover hooks clear the edge of the front panel display cover, remove the top cover by lifting it.
8. Lift the cartridge carrier, with each cartridge you want to remove, straight up from the autoloader.



**NOTE:** To remove the carrier directly in front of the Import/Export slot, gently rotate the carousel counterclockwise by moving the belt or carriers until the carrier is no longer in front of the Import/Export slot.

9. On each carrier, carefully pull the cartridge lock lever away from the carrier, allowing the cartridge to slide out of the carrier.

#### Pull Cartridge Release Lever

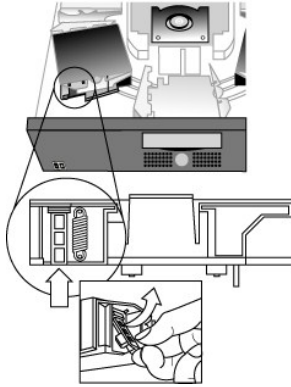

10. After removing the cartridges from the desired carriers, reinstall each carrier on the autoloader belt (see "[Installing the Carrier](#)").
11. Make sure that the rollers on the bottom of the carrier are aligned in the carrier tracks.
12. Make sure that the belt post beneath each carrier is inserted into the proper autoloader belt loop.

 **NOTE:** There are unused loops on the belt. The proper belt loops have an extra bump on the outside of the loop (see "[Installing the Carrier](#)").

#### Installing the Carrier

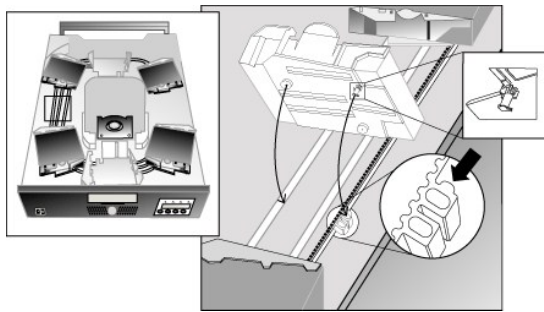

13. Insert the peg on the bottom of the cartridge carrier into the slot in the belt, then gently turn the cartridge carrier in place to lock it in the belt.  
  
Ensure the carrier is properly installed on the belt by gently pressing on the top of the carrier and sliding it back and forth. If it is properly attached to the belt, it should not move. If it does, reinstall the carrier.
14. Replace the top cover of the autoloader and reinstall the cover screws and mounting brackets (if rack mounted).

## Autoloader Error Codes

If an error occurs during operation of the autoloader, the autoloader stops the current operation and displays an error code on the top line of the LCD screen. Unless otherwise noted in "[Autoloader Error Codes](#)," attempt to resolve the error by resetting or power cycling the autoloader and retrying the last operation. If the error persists, [contact](#) Dell.

To view the error log follow these steps:

1. From the Home screen or main menu, press + or - until **Information** appears on the top line of the LCD screen.
2. Press **Enter** to access the available options.
3. Press + or - until **View Error Log** appears on the LCD screen.  
  
The LCD screen also displays the quantity of errors and events currently stored in the error log.
4. Press **Enter** to access the most recently logged error message.
5. Press + or - to display each error in the log.
6. Press **Cancel** when finished.

A description of each of the error codes is provided in the following table:

#### Error Codes

Error Code	Description	Details
3 0 81	Invalid Command Error.	This error indicates that the autoloader received an undefined command or an invalid parameter within a command.
3 0 82	Device Status Not Suitable to Execute This Command.	If the robotics are busy, some commands cannot be executed at the same time. This error indicates a probable violation. This is not an error condition, but does result in <b>Busy</b> being reported to the host for the requested SCSI command.
3 0 83	Inventory Not Valid.	The cartridge inventory is not valid because of manual changes or previous fatal errors. Update the inventory using the <b>Re-inventory</b> option in the <b>Configuration</b> menu. See " <a href="#">Creating an Inventory of Cartridges</a> " or power cycle.
3 0 84	Source Empty.	There is no cartridge in the location from which a cartridge move was issued.
3 0 85	Destination Full.	The location to which a cartridge move was issued already contains a cartridge.
3 0 86	Import/Export Slot Access Rejected.	User attempted to access the Import/Export slot, but media removal was prevented by the host.
3 0 87	Operation Timeout.	A command did not complete in the required amount of time.
3 0 88	Communications Error During Loop-Back.	Power cycle the autoloader and attempt the operation again. If the error recurs, <a href="#">contact</a> your technical support representative.
3 0 89	System Test Timeout.	There was a communication timeout between the drive and loader during the System Test.
3 0 8F	Recovered Loader Error.	Loader error recovery successful. Your diagnostic tool can provide details of the original loader error.
3 0 90	Mechanical Initialization Failure.	The robotics were not able to move to the safe mechanical initialization position. Manual intervention is necessary.
3 0 91	Inventory Scan Failure.	Fatal robotic error occurred during the inventory scan.
3 0 92	Preposition Failed.	Belt positioning error occurred during <b>Preposition</b> command.
3 0 93	Cartridge Load Error.	A failure occurred while trying to load a cartridge a slot to the drive.
3 0 94	Cartridge Unload Error.	A failure occurred while trying to unload a cartridge from the drive to its slot.
3 0 95	Import Error.	An error occurred while trying to import a data cartridge to a carousel slot.
3 0 96	Export Error.	An error occurred while trying to export a data cartridge from its carousel slot. Can be caused by an empty slot that is expected to be full.
3 0 A0	Carousel Motion Failure.	Error occurred during carousel movement (Position Not Found). Could be caused by a missing or misaligned cartridge carrier, or an obstruction, or unexpected cartridge in either the carousel path or Import/Export slot.
3 0 A1	Cartridge Transport Position Error.	Cartridge transport element is unable to reach its desired position. Failure occurred while trying to place a cartridge into or remove a cartridge from the drive or a slot.
3 0 A2	Gripper Position Error.	Gripper unable to reach position.
3 0 A3	Cartridge Pick Error.	Error occurred while trying to pull a cartridge from the drive or a carousel slot.
3 0 A4	Import/Export Slot Position Error.	The Import/Export slot door was not in the requested position during device operation. Can be caused by manually opening the door, or a cartridge or other obstruction is blocking the door. Try removing the cartridge or obstruction, then power cycle or reset the autoloader.
3 0 A5	Fan Error.	Autoloader Processor Detected a Fan Error.
3 0 B0	ROM Error.	Power cycle the autoloader and attempt the operation again. If the error recurs, <a href="#">contact</a> your technical support representative.
3 0 B1	RAM Error.	Power cycle the autoloader and attempt the operation again. If the error recurs, <a href="#">contact</a> your technical support representative.
3 0 B2	NVRAM Error.	Power cycle the autoloader and attempt the operation again. If the error recurs, <a href="#">contact</a> your technical support representative.
3 0 B3	Controller Timer Failure.	An unrecoverable failure has occurred in the controller timer circuit.
3 0 B4	Loader To Drive Communication IC Error.	Failure in IC handling loader to drive communication.
3 0 B5	Display Error.	Power cycle the autoloader and attempt the operation again. If the error recurs, <a href="#">contact</a> your technical support representative.
3 0 B6	Memory Error.	Power cycle the autoloader and attempt the operation again. If the error recurs, <a href="#">contact</a> your technical support representative.
3 0 B7	Timeout on Autoloader Command	Power cycle the autoloader and attempt the operation again. If the error recurs, <a href="#">contact</a> your technical support representative.
3 0 BC	Drive Bug-Checked.	Power cycle the autoloader and attempt the operation again. If the error recurs, <a href="#">contact</a> your technical support representative.
3 0 BF	Fatal Error.	Power cycle the autoloader and attempt the operation again. If the error recurs, <a href="#">contact</a> your technical support representative.

---

[Back to Contents Page](#)

[Back to Contents Page](#)

## Getting Help

- [Technical Assistance](#)
  - [Dell Enterprise Training and Certification](#)
  - [Problems With Your Order](#)
  - [Product Information](#)
  - [Returning Items for Warranty Repair or Credit](#)
  - [Before You Call](#)
- 

## Technical Assistance

If you need assistance with a technical problem, perform the following steps:

1. Complete the procedures in "Troubleshooting Your System."
2. Run the system diagnostics and record any information provided.
3. Make a copy of the [Diagnostics Checklist](#), and fill it out.
4. Use Dell's extensive suite of online services available at Dell Support at [support.dell.com](http://support.dell.com) for help with installation and troubleshooting procedures.

For more information, see "Online Services."

5. If the preceding steps have not resolved the problem, call Dell for technical assistance.

**NOTE:** Call technical support from a phone near or at the system so that technical support can assist you with any necessary procedures.

**NOTE:** Dell's Express Service Code system may not be available in all countries.

When prompted by Dell's automated telephone system, enter your Express Service Code to route the call directly to the proper support personnel. To obtain your express service code, go to [support.dell.com](http://support.dell.com) and enter your service tag. Your express service code will be displayed. Please make a note of the express service code for use when calling technical support.

For instructions on using the technical support service, see "[Technical Support Service](#)" and "[Before You Call](#)."

**NOTE:** Some of the following services are not always available in all locations outside the continental U.S. Call your local Dell representative for information on availability.

## Online Services

You can access Dell Support at [support.dell.com](http://support.dell.com). Select your region on the **WELCOME TO DELL SUPPORT** page, and fill in the requested details to access help tools and information.

You can contact Dell electronically using the following addresses:

1. World Wide Web

[www.dell.com/](http://www.dell.com/)

[www.dell.com/ap/](http://www.dell.com/ap/) (Asian/Pacific countries only)

[www.dell.com/jp](http://www.dell.com/jp/) (Japan only)

[www.euro.dell.com](http://www.euro.dell.com) (Europe only)

[www.dell.com/la](http://www.dell.com/la) (Latin American countries)

[www.dell.ca](http://www.dell.ca) (Canada only)

- 1 Anonymous file transfer protocol (FTP)

[ftp.dell.com/](ftp://ftp.dell.com/)

Log in as user: `anonymous`, and use your e-mail address as your password.

- 1 Electronic Support Service

[support@us.dell.com](mailto:support@us.dell.com)

[apsupport@dell.com](mailto:apsupport@dell.com) (Asian/Pacific countries only)

[support.jp.dell.com](mailto:support.jp.dell.com) (Japan only)

[support.euro.dell.com](mailto:support.euro.dell.com) (Europe only)

- 1 Electronic Quote Service

[sales@dell.com](mailto:sales@dell.com)

[apmarketing@dell.com](mailto:apmarketing@dell.com) (Asian/Pacific countries only)

[sales\\_canada@dell.com](mailto:sales_canada@dell.com) (Canada only)

- 1 Electronic Information Service

[info@dell.com](mailto:info@dell.com)

## AutoTech Service

Dell's automated technical support service AutoTech provides recorded answers to the questions most frequently asked by Dell customers about their portable and desktop computer systems.

When you call AutoTech, use your touch-tone telephone to select the subjects that correspond to your questions.

The AutoTech service is available 24 hours a day, 7 days a week. You can also access this service through the technical support service. See the contact information for your region.

## Automated Order-Status Service

To check on the status of any Dell™ products that you have ordered, you can go to [www.dell.com](http://www.dell.com), or you can call the automated order-status service. A recording prompts you for the information needed to locate and report on your order. See the contact information for your region.

## Technical Support Service

Dell's technical support service is available 24 hours a day, 7 days a week, to answer your questions about Dell hardware. Our technical support staff use computer-based diagnostics to provide fast, accurate answers.

To contact Dell's technical support service, see "[Before You Call](#)" and then see the contact information for your region.

---

## Dell Enterprise Training and Certification

Dell Enterprise Training and Certification is available; see [www.dell.com/training](http://www.dell.com/training) for more information. This service may not be offered in all locations.

---

## Problems With Your Order

If you have a problem with your order, such as missing parts, wrong parts, or incorrect billing, contact Dell for customer assistance. Have your invoice or packing slip available when you call. See the contact information for your region.

---

## Product Information

If you need information about additional products available from Dell, or if you would like to place an order, visit the Dell website at [www.dell.com](http://www.dell.com). For the telephone number to call to speak to a sales specialist, see the contact information for your region.

---

## Returning Items for Warranty Repair or Credit

Prepare all items being returned, whether for repair or credit, as follows:

1. Call Dell to obtain a Return Material Authorization Number, and write it clearly and prominently on the outside of the box.

For the telephone number to call, see the contact information for your region.

2. Include a copy of the invoice and a letter describing the reason for the return.
3. Include a copy of any diagnostic information (including the Diagnostics Checklist) indicating the tests you have run and any error messages reported by the system diagnostics.
4. Include any accessories that belong with the item(s) being returned (such as power cables, media such as CDs and diskettes, and guides) if the return is for credit.
5. Pack the equipment to be returned in the original (or equivalent) packing materials.

You are responsible for paying shipping expenses. You are also responsible for insuring any product returned, and you assume the risk of loss during shipment to Dell. Collect-on-delivery (C.O.D.) packages are not accepted.

Returns that are missing any of the preceding requirements will be refused at our receiving dock and returned to you.

---

## Before You Call

**NOTE:** Have your Express Service Code ready when you call. The code helps Dell's automated-support telephone system direct your call more efficiently. To obtain your express service code, go to [support.dell.com](http://support.dell.com) and enter your service tag. Your express service code will be displayed. Please make a note of the express service code for use when calling technical support.

Remember to fill out the [Diagnostics Checklist](#). If possible, turn on your system before you call Dell for technical assistance and call from a telephone at or near the computer. You may be asked to type some commands at the keyboard, relay detailed information during operations, or try other troubleshooting steps possible only at the computer system itself. Ensure that the system documentation is available.



**CAUTION:** Before servicing any components inside your computer, see your *System Information Guide* for important safety information.

Diagnostics Checklist
Name:
Date:
Address:
Phone number:
Service Tag (bar code on the back of the computer):
Express Service Code:
Return Material Authorization Number (if provided by Dell support technician):
Operating system and version:
Peripherals:
Expansion cards:
Are you connected to a network? Yes No
Network, version, and network card:
Programs and versions:
See your operating system documentation to determine the contents of the system's start-up files. If possible, print each file. Otherwise, record the contents of each file before calling Dell.
Error message, beep code, or diagnostic code:
Description of problem and troubleshooting procedures you performed:

[Back to Contents Page](#)

[Back to Contents Page](#)

## Installing the Autoloader: Dell™ PowerVault™ 122T DLT VS80 Autoloader User's Guide

- [Installation Overview](#)
  - [Understanding Autoloader Features](#)
  - [Bar Code Reader](#)
  - [SCSI Requirements](#)
  - [Product Overview](#)
  - [Choosing a Location](#)
  - [Unpacking the Autoloader](#)
  - [Identifying Product Components](#)
  - [Connecting the SCSI and Power Cables](#)
  - [Preparing the Host and Verifying the Connection](#)
  - [Installing the Device Drivers](#)
- 

### Installation Overview

Installing the autoloader consists of the following steps, which are explained in more detail later in this Section:

1. Choose a location for the autoloader (see "[Choosing a Location](#)").
  2. Unpack and check the autoloader for shipping damage (see "[Unpacking the Autoloader](#)").
  3. Identify the accessories that come with the autoloader (see "[Identifying Product Components](#)").
  4. Install the autoloader in a computer rack or select a table or desktop near the host server. If installing a rack mount unit, refer to your rack *Installation Guide*.
  5. Shut down, turn off, and remove power from the server and all devices attached to the server (see "[Connecting the SCSI and Power Cables](#)").
  6. Attach the SCSI cable to the autoloader and server's SCSI host adapter (see "[Connecting the SCSI and Power Cables](#)").
  7. Attach the power cable to the autoloader and plug in the power cable to the nearest power outlet (see "[Connecting the SCSI and Power Cables](#)"). Power the autoloader on to ensure it passes the Power-on Self Test.
  8. Set the SCSI ID for the autoloader (see "[Changing the SCSI ID](#)").
  9. Set up the host and verify the connection (see "[Preparing the Host and Verifying the Connection](#)").
- 

### Understanding Autoloader Features

The autoloader is a SCSI-2 Low Voltage Differential (LVD) data storage device that incorporates a Dell PV122T DLT VS80 tape drive and eight tape slots. The autoloader operates as a single SCSI device with two Logical Unit Numbers (LUNs), one for the tape drive (0) and the other for the autoloader robotics (1). The autoloader uses up to eight DLTtape™IV data cartridges, providing a maximum formatted capacity of 640 Gigabytes and a sustained data transfer rate as high as 360 MB per minute, assuming a 2:1 compression ratio.

The autoloader is compatible with most operating systems and environments that support the SCSI interface, but requires either direct support from the operating system or a compatible backup application to take full advantage of its many features.

---

### Bar Code Reader

Your autoloader may have come equipped with an optional bar code reader. The bar code reader is enclosed in a plastic housing that protrudes out the back panel of the autoloader, just above the SCSI connectors. The bar code reader automatically scans each cartridge in the carousel upon power up, after a reset, after an import or export, or when a re-inventory command is issued (see "[Creating an Inventory of Cartridges](#)"). Beyond that, there is no user interface with the bar code reader via the front panel operator controls or LCD screen. The information from each label is stored in memory and available through SCSI to the computer's operating system or backup application upon request.

If utilizing the bar code reader, you must insert bar code labels into the slide-in slot on the front of each cartridge. The labels must conform to ANSI/AIM BC1 - 1995 Uniform Symbology Specification Code 39. A set of bar code labels is included with the autoloader. Refer to [www.dell.com](http://www.dell.com) for information on obtaining additional bar code labels.

---

### SCSI Requirements

The autoloader incorporates a wide SCSI-2, Low-Voltage Differential (LVD) SCSI bus. Make sure your SCSI host adapter or controller supports these standards.

The autoloader can be attached to a Single Ended (SE) SCSI bus, but this is not recommended because it restricts performance. If you connect the autoloader to an SE SCSI bus, or if there are SE devices attached to the same SCSI bus, the autoloader's performance is limited to the maximum data transfer speed and maximum cable lengths of the SE bus. The autoloader is NOT compatible with a standard differential (Diff) or High Voltage Differential (HVD) SCSI bus. The autoloader can be attached to a narrow (50-pin) SCSI bus, but this is not recommended as performance will be restricted. Attaching to a narrow (50-pin) bus requires a customer-supplied 68-pin to 50-pin adapter that terminates the unused 18 pins. These adapters are sometimes labeled high-byte termination.

---

### Product Overview



## Front Panel Controls

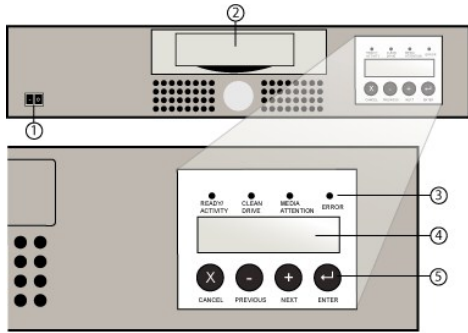

- 1 Power Switch
- 2 Media Door
- 3 Front Panel LEDs
- 4 Front Panel LCD Screen
- 5 Control Keys

## Back Panel Overview

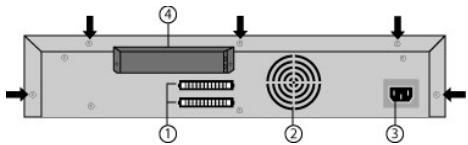

- 1 68-pin SCSI Connectors
- 2 Fan Vent
- 3 Power Connector
- 4 Bar Code Reader (optional)



**NOTE:** The arrows indicate the screws on the back of the unit that need to be removed if you want to remove the cover. Three additional screws on each side of the unit must also be removed in order to lift the top cover.

## Choosing a Location

Choose a location that meets the following criteria (see "[Technical Specifications](#)"):

### Standalone Requirements

Select a location that is flat, sturdy, level, and close to a host server. Do not place the autoloader on the floor or other carpeted surfaces.



**NOTICE:** Do not place the autoloader on its side or upside down or stack items that weigh more than 15 KG (33 lb) on top of the autoloader.

### Rack Requirements

Standard 19-inch rack with 2U of clearance.

### Room Temperature

10–35°C (50–95°F)

### Power Source

AC power voltage: 100–127 VAC; 200–240 VAC  
Line frequency: 50–60 Hz



**NOTE:** Locate the AC outlet near the autoloader. The AC power cord is the product's main AC disconnect device and must be easily accessible at all times.

### Weight

10 kg (22 lb)

### Air Quality

Minimize sources of particulate contamination. Avoid areas near frequently used doors and walkways, stacks of supplies that collect dust, printers, and smoke-filled rooms.



**NOTICE:** Excessive dust and debris can damage tapes and tape drives.

### Humidity

20–80% RH

### Clearance

Back: Minimum of 15.4 cm (6 in)  
Front: Minimum of 30.8 cm (12 in)  
Sides: Minimum of 5.08 cm (2 in)

## Unpacking the Autoloader

Before you begin, clear a desk or table so that you can unpack the autoloader. You also need to select an open 2U computer rack location or choose a desk top location near the server that will host the autoloader.

- ➡ **NOTICE:** If the room in which you are working differs from the temperature in which the autoloader was shipped or stored by 15°C (30° F) or more, let the autoloader acclimate to the surrounding environment for at least 12 hours before opening the shipping carton.

Unpack and inspect the autoloader for shipping damage by doing the following:

1. Clear a table or desk so that you have room to unpack the autoloader.
2. Inspect the shipping box for damage. If you notice any damage, report it to the shipping company immediately.
3. Open the shipping box and remove the accessories package. Set the accessories package aside for now.
4. Lift the autoloader and padding out of the box and place it on the work surface, top facing up. *Do not set the autoloader on either end or sides.*
5. Carefully remove the shipping padding from the left and right sides of the autoloader. Then remove the bag from the autoloader. *Save the packing materials in case you need to move or ship the autoloader in the future.*

---

## Identifying Product Components

### Accessories

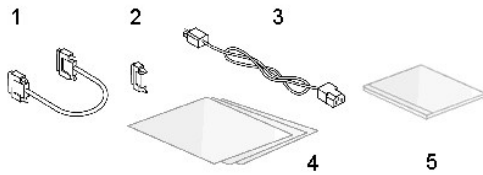

- 1 SCSI Cable
- 2 SCSI Terminator
- 3 Power Cable
- 4 Quick Start Guide
- 5 CD (Drivers and Documentation)

### Rack Kit Components (if rackmount unit)

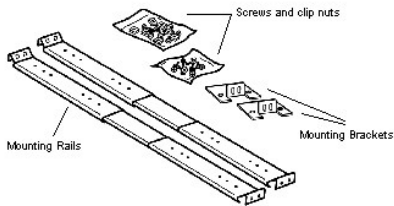

---

## Connecting the SCSI and Power Cables

To connect the SCSI and power cables to the autoloader, follow these steps:

1. Shut down and turn off the selected server. Turn off all attached accessory devices, such as printers and other SCSI devices. Remove the power cables from the server and all attached accessories.

- ➡ **NOTICE:** Failure to remove the power cables from these devices could result in damage to the autoloader.

2. Attach one end of the SCSI cable (included in the accessory kit) to one of the connectors on the back panel of the autoloader.
3. Attach the other end of the SCSI cable to the connector on the SCSI host adapter or to the connector on the previous device on the SCSI bus.

### Attaching SCSI and Power Cables (illustrated with optional bar code reader)

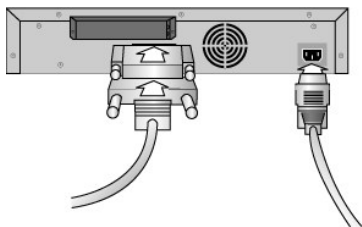

If the supplied SCSI cable does not fit the connector on your SCSI host adapter, you either have an incompatible SCSI host adapter or you need to purchase a cable adapter. Contact your service representative or your SCSI host adapter manufacturer for information.

1. Attach the terminator to the remaining SCSI connector on the back panel of the autoloader (if the autoloader is the last or only device on the SCSI bus). Otherwise, attach the cable to the next device on the SCSI bus. Make sure that the last device on the SCSI bus is properly terminated.
2. Attach the female connector of the power cable to the power connector on the back panel of the autoloader.
3. Plug in the power cable to the nearest properly grounded power outlet.
4. Plug in the host server or workstation and all attached devices.
5. Turn on the autoloader by setting the power switch on the front panel to the ON position. Turn on any other devices you turned off earlier. Check the LCD screen to make sure the autoloader is receiving power. If it is not, check the power connections and your power source.

During the Power-on Self Test (POST), all four LEDs are illuminated briefly, followed by only the Ready/Activity LED flashing. When the initialization sequence is complete, the LCD screen displays the Home screen.

6. Turn on the server.

---

## Preparing the Host and Verifying the Connection

If necessary, install a SCSI host adapter, software, and compatible drivers. Refer to the manuals for the host computer and SCSI host adapter for detailed instructions. In addition, follow these general guidelines:

1. When the host server is powered on, install software, and/or drivers that are compatible with the autoloader (see "[Installing the Device Drivers](#)"). Software compatibility information is available at [support.dell.com](http://support.dell.com). Most backup software packages require an additional module to communicate with the autoloader robotics.
1. If the host server is connected to a network, check with the system administrator before turning off power.
1. Use proper procedures to prevent electrostatic discharge (ESD). Use wrist-grounding straps and anti-static mats when handling internal components.
1. Make sure that the host server has an open expansion slot.
1. Make sure that your backup application supports the SCSI host adapter.
1. Depending on the server configuration, you may need to change the SCSI ID of the autoloader (see "[Changing the SCSI ID](#)").
1. Ensure the autoloader is properly terminated. If the autoloader is the only SCSI device—other than the SCSI host adapter—on the selected SCSI bus, it must be terminated. Likewise, if the autoloader is physically the last SCSI device on the SCSI bus, it must be terminated. Only the devices physically at the beginning and end of the SCSI bus should be terminated.
1. Verify the connection between the autoloader and host by going to: **Settings>Control Panel>SCSI Adapter** in Microsoft® Windows NT® or **Settings>Control Panel>System>Hardware>Device Manager>Tape Drive** and/or **Media Changer** in Microsoft Windows® 2000 and Windows Server 2003. For more information on verifying the connection of SCSI devices, consult the operating system documentation.

---

## Installing the Device Drivers

There are two device drivers associated with the Dell PowerVault 122T Autoloader. One for the autoloader itself, and a second for the VS80 Tape Drive within the autoloader.



**NOTE:** The device drivers supplied on the *Dell PowerVault 122T DLT VS80 Autoloader User's Manual and Drivers CD* are required if you intend to use the Microsoft Windows 2000 native backup application. Commercial backup applications provide all necessary device driver support. Refer to [support.dell.com](http://support.dell.com) for a list of compatible backup applications. Please note that Microsoft Windows NT does not include native support for Autoloaders. A backup application must be used if using the Dell PowerVault 122T Autoloader under Microsoft Windows NT.

### Tape Drive Device Driver

Microsoft Windows 2000:

1. Make sure that you are logged on to the host server with administrator privileges.
2. Insert the *Dell PowerVault 122T Autoloader User's Manual and Drivers CD* into the CD drive on the host server.
3. Open the device manager (please refer to your specific OS documentation for instructions). For example, right-click the **My Computer** icon on the

Windows desktop, click **Manage**, and then click **Device Manager**.

The VS80 drive should be listed under the ? **Other Devices** item as **BNCHMARK VS640 SCSI Sequential Device**.

4. Right-click the **BNCHMARK VS640 SCSI Sequential Device** listing, click **Uninstall**, and then click **OK** to confirm that you want to remove the device.
5. Click **Action** in the upper-left corner of the **Computer Management** dialog box.
6. Click **Scan for Hardware Changes**. Windows 2000 now scans for the PowerVault 122T DLT VS80 drive. The VS80 drive appears under ? **Other Devices** again.
7. Right-click the **BNCHMARK VS640 SCSI Sequential Device** listing and click **Properties**.
8. Select the **Driver** tab.
9. Click **Update Driver**.
10. When the Upgrade Device Driver Wizard appears, click **Next**.
11. Click **Display a list...** and then click **Next**.
12. Scroll down and click **Tape Drive**, and then click **Next**.
13. Click **Have Disk**, type `d:\drivers\w2k\vs80\vs80`, replacing `d:` with the drive letter for the CD drive into which you inserted the *Dell PowerVault 122T Autoloader User's Manual and Drivers CD*, and then click **OK**.
14. Click the **Dell PowerVault 122T VS80** entry and then click **Next**.



**NOTE:** Depending on the status of your system and the exact path taken to select the device driver, the driver may appear as **Ditvsdtp.inf**.

15. Click **Next** again to install the driver.
16. Click **Finish**.
17. Close the **Device Properties** dialog box.

The drive now appears in **Device Manager** under **Tape Drives** as a **Dell PowerVault 122T VS80** and is ready to use.

## Autoloader Device Driver

Microsoft Windows 2000:

1. Make sure that you are logged on to the host server with administrator privileges.
2. Insert the *Dell PowerVault 122T Autoloader User's Manual and Drivers CD* into the CD drive on the host server.
3. Right-click the **My Computer** icon on the Windows desktop, click **Manage**, and then click **Device Manager**.
4. The autoloader should be listed under **Medium Changers** as **Unknown Medium Changer Device**.
5. Right-click the **Unknown Medium Changer Device** listing, click **Uninstall**, and then click **OK** to confirm that you want to remove the device.
6. Click **Action** in the upper-left corner of the **Computer Management** dialog box.
7. Click **Scan for Hardware Changes**.  
  
Windows 2000 now scans for the Dell PowerVault 122T DLT VS80 Autoloader. The Autoloader appears under **Medium Changers** again.
8. Right-click the **Unknown Medium Changer Device** listing and click **Properties**.
9. Select the **Driver** tab.
10. Click **Update Driver**.
11. When the Upgrade Device Driver Wizard appears, click **Next**.
12. Click **Display a list...** and then click **Next**.
13. Click **Have Disk**, type `d:\drivers\w2k\vs80\autoloader`, replacing `d:` with the drive letter for the CD drive into which you inserted the *Dell PowerVault 122T Autoloader User's Manual and Drivers CD*, and then click **OK**.
14. Click the **Dell PowerVault 122T Autoloader** entry and click **Next**.



**NOTE:** Depending on the status of your system and the exact path taken to select the device driver, the driver may appear as **Dltvsdmc.inf**.

15. Click **Next** again to install the driver.
16. Click **Finish**.
17. Close the **Device Properties** dialog box.

The autoloader now appears in **Device Manager** under **Medium Changers** as a **Dell PowerVault 122T Autoloader**, and is ready to use.



[Back to Contents Page](#)

[Back to Contents Page](#)

## **Introduction: Dell™ PowerVault™ 122T DLT VS80 Autoloader User's Guide**

---

### **Overview**

The PowerVault 122T VS80 autoloader is the first fully automated, rack mountable, 2U (3.34" height, 16.5" width), enterprise class DLT tape storage system designed to provide unattended, near-line and off-line data storage. This high throughput, high capacity, storage device is optimized for applications that provide archiving, hierarchical storage management, backup and retrieval functionality for low to mid-range servers and networks.

The autoloader is SCSI-2 compatible and operates as a single SCSI ID/two LUN data storage device. The PowerVault 122T VS80 autoloader is equipped with a Quantum VS80 tape drive and contains up to eight DLTapeIV cartridges, providing a compressed capacity of 640 GB and a sustained data transfer rate as high as 21.6 GB per hour.

The autoloader is compatible with the most popular operating systems and environments supporting a SCSI LVD interface but requires direct support from the operating system or a compatible backup application to take full advantage of its many features.

---

[Back to Contents Page](#)

## Operating the Autoloader: Dell™ PowerVault™ 122T DLT VS80 Autoloader User's Guide

- [Operator's Panel Overview](#)
  - [Understanding the Menu Structure](#)
  - [Using Cartridges](#)
  - [Cleaning the Tape Drive](#)
  - [Creating an Inventory of Cartridges](#)
- 

### Operator's Panel Overview

The Operator's Panel consists of four LEDs, four buttons, and a 2-line by 16-character LCD screen. The Operator's Panel provides everything you need to monitor autoloader status and to control all of its functions.

The display defaults to the Home screen. The Home screen consists of the autoloader status on the top line and the current cartridge inventory on the second line. If the tape drive does not have a cartridge loaded, the top line displays `DELL PV-122T` (see "[Home Screen](#)").

The cartridge inventory indicates all slots that contain a cartridge by displaying the slot number. Empty slots are indicated by a dash or hyphen (-).

### Home Screen

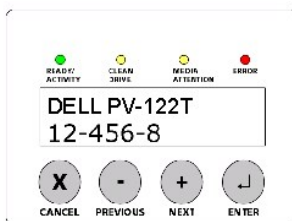

An exclamation point (!) displayed in the inventory indicates that the autoloader has identified a cartridge in the indicated slot that is either an invalid cartridge type or has had a media error. These conditions can be caused by faulty media, media that has been previously written in an invalid format, or dirty read/write heads in the tape drive. The Media Attention LED is also illuminated in this case (see "[LED Indicators](#)"). Exporting the indicated cartridge will clear the error condition (see "[Exporting Cartridges](#)"). If these symptoms occur on multiple known good cartridges, consider cleaning the tape drive (see "[Cleaning the Tape Drive](#)"). If a particular cartridge causes these symptoms repeatedly, that cartridge may be defective or invalid.

Occasionally you may see the message `In Transit`, which indicates:

- 1 An error condition has caused a cartridge to be left between its slot and the drive. Power cycle or reset the autoloader to clear this condition.
- 1 A cartridge is unexpectedly found in the Import/Export slot opening. Power cycle or reset the autoloader to clear this condition.

If the tape drive has a cartridge loaded, the top line displays `Drive loaded`. The cartridge currently loaded in the drive is indicated by an alternating black block and the slot number. This display can also indicate that the specified cartridge is being loaded, unloaded, imported, or exported, as well as indications of read to, write to, and so on. The autoloader status line indicates the current operation. An example of this display is shown below.

### Home Screen, Drive Loaded

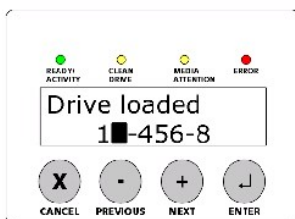

### LED Indicators

The Operator's Panel includes four LED indicators that provide a variety of information as detailed in the following table:

LED	Color	Description
Ready/Activity	Green	Illuminated when power is on. Blinking whenever there is tape drive or autoloader robotics activity.

<b>Clean Drive</b>	Amber	Illuminated when the tape drive needs to be cleaned. Indicates that 250 tape motion hours have passed since the last cleaning. The LED turns off when cleaning is successfully completed. (See <a href="#">Cleaning the Tape Drive</a> .)
<b>Media Attention</b>	Amber	Illuminated if a media related error has occurred. This condition can be the result of dirty read/write heads in the tape drive, or if an invalid or damaged cartridge is inserted. The offending cartridge will show an '!' in the cartridge inventory display for the corresponding slot. Exporting the indicated cartridge will clear the error condition (see <a href="#">Exporting Cartridges</a> ). If these symptoms occur on multiple known good cartridges, consider cleaning the tape drive (see <a href="#">Cleaning the Tape Drive</a> ). If a particular cartridge causes these symptoms repeatedly, that cartridge may be defective or invalid.
<b>Error</b>	Red	Illuminated if an unrecoverable tape drive or autoloader error occurs. A corresponding error message appears on the LCD screen (see <a href="#">Autoloader Error Codes</a> ).

## Operator's Panel Control Buttons

The Operator's Panel includes four buttons that provide access to all operations and information menus.

Button	Description
<b>Cancel</b>	Cancels the current menu option and returns to the previous menu level or Home screen.
<b>Previous</b>	Selects the previous item or value in the currently displayed menu.
<b>Next</b>	Selects the next item or value in the currently displayed menu.
<b>Enter</b>	Executes the current menu or selects the current option displayed on the LCD screen.

## Understanding the Menu Structure

### Operator's Panel Menu Structure

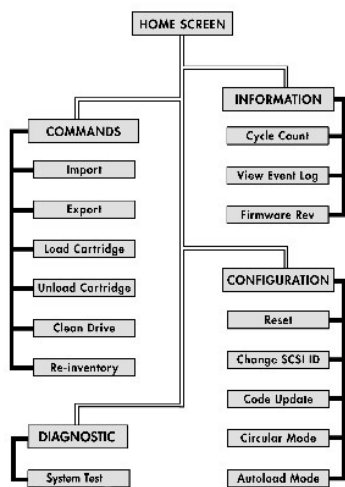

## Using Cartridges

Before you use the autoloader, make sure you observe these general rules:

- 1 **Use only DLTape™IV cartridges.** The tape drive in the autoloader can read, but not write DLTapeIV cartridges that are written in the DLT4000 format. You can order tape cartridges at [www.dell.com/tapebackup](http://www.dell.com/tapebackup). Make sure all cartridges that you want to use for writing have either never been written to, have been thoroughly degaussed, or have been written to only with the VS80 tape drive in the autoloader or another VS80 or DLT1 tape drive. The tape drive rejects all other formats. If you want to reuse cartridges that have been formatted with another manufacturer's drive, use a magnetic bulk eraser or degausser to prepare the cartridges for use with the autoloader. Many common degaussers are not adequate for DLT media. Contact your support representative for proper degaussing recommendations.
- 1 **Clean the tape drive when the Clean Drive LED is illuminated**, or if there is any other indication that the drive is having trouble reading or writing, such as if the Media Attention LED is illuminated, or there is an exclamation point (!) in the inventory display. Be sure to use only DLT1 compatible cleaning cartridges. The tape drive rejects all other types of cleaning cartridges.



**NOTE:** The autoloader automatically unloads any other cartridge types and any cartridges whose format it cannot read. If you experience any failures with reused formatted (degaussed) cartridges, the degaussing may not have been sufficient to fully erase the data. If this happens, use another cartridge (preferably a new, unformatted DLTapeIV cartridge) before suspecting other system components.

## Importing Cartridges

This option forces the autoloader to import a cartridge into a specific empty slot in the carousel. To import tapes into the autoloader:

1. Make sure the write-protect switch is set as desired for each data cartridge (see [Write-Protecting Cartridges](#)). If applicable, insert a bar code label into the slide-in slot on the front of each cartridge (see [Bar Code Reader](#)).



- From the Home screen or main menu, press + or - until **Commands** appears on the top line of the LCD screen.
- Press **Enter** to access the available options.
- Press + or - until **Import** appears on the LCD screen, and then press **Enter**.
- Press + or - until the desired slot number appears on the LCD screen and press **Enter**. You are not given the option to import a cartridge to an occupied slot.
- When **Insert Cartridge Slot** appears on the LCD screen and the media door opens, insert the desired data cartridge into the media door so that the write-protect switch is facing out from the autoloader and towards the right.

 **NOTE:** If you are using the Operator's Panel to clean the drive, import the cleaning cartridge only when the operator panel requests it. You may keep a cleaning cartridge in the autoloader if the backup software can manage the drive cleaning.

- Repeat steps 5 and 6 as needed for any additional cartridges.
- Press **Cancel** when you are done importing cartridges.
- Verify that the LCD screen shows that the desired slots have cartridges installed.

### Importing a Cartridge

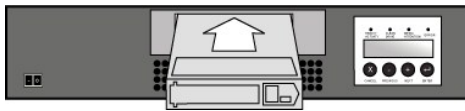

### Exporting Cartridges

This option moves a cartridge from a specific slot to the media door. To export one or more cartridges from the autoloader, follow these steps:

- From the Home screen or main menu, press + or - until **Commands** appears on the top line of the LCD screen, and then press **Enter**.
- Press + or - until **Export** appears on the LCD screen, and then press **Enter**.
- Press + or - until the desired slot number appears on the LCD screen, and then press **Enter**. You are not given the option to export from an empty slot.
- When **Remove Cartridge** appears on the LCD screen and the cartridge is ejected through the media door, remove the exported cartridge from the autoloader, and then press **Enter**.
- Repeat steps 3 and 4 as needed for any additional cartridges.
- Press **Cancel** when you are finished exporting cartridges.
- Make sure the LCD screen indicates that the desired slots contain cartridges.

### Exporting a Cartridge

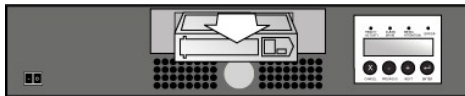

### Loading Cartridges

This option loads a cartridge from the autoloader carousel into the tape drive. To use this option, follow these steps:

- From the Home screen or main menu, press + or - until **Commands** appears on the top line of the LCD screen, and then press **Enter**.
- Press + or - until **Load Cartridge** appears on the LCD screen, and then press **Enter**.
- Press + or - until the desired slot number appears on the LCD screen, and then press **Enter**. The slot number you select indicates the cartridge to be loaded into the tape drive.

 **NOTE:** Only slot numbers that contain cartridges are displayed.

- Status messages will be displayed while the cartridge is loading. **Drive Stopped** will be displayed when the operation is complete.
- Press **Cancel** when you are finished loading the cartridge.

### Unloading Cartridges

This option unloads the cartridge from the tape drive into its original slot. To use this option, follow these steps:

- From the Home screen or main menu, press + or - until **Commands** appears on the top line of the LCD screen, and then press **Enter**.
- Press + or - until **Unload Cartridge** appears on the LCD screen. Press **Enter** to unload the cartridge from the tape drive.



**NOTE:** Status messages will be displayed while the cartridge is unloading. `Drive Empty` will be displayed when the operation is complete.

3. Press **Cancel** when you are done unloading the cartridge.

## Write-Protecting Cartridges

All cartridges have a write-protect switch to prevent accidental erasure or overwriting of data. Before loading a cartridge into the autoloader, make sure the write-protect switch on the front of the cartridge is positioned as desired:

- 1 Slide the switch to the **left** to write-protect the cartridge. A small orange rectangle is visible, indicating that the cartridge is write-protected.
- 1 Slide the switch to the **right** to allow the autoloader to write data to the cartridge.

### Write-Protecting a Cartridge

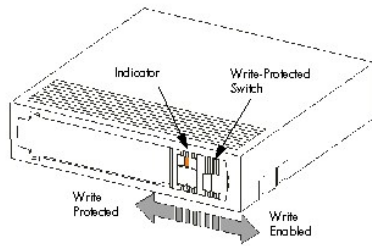

## Maintaining Cartridges

To ensure the longest possible life for all of your DLTtapeIV cartridges, follow these guidelines:

- 1 Do not drop or strike a cartridge. Excessive shock can displace the tape leader, making the cartridge unusable and possibly damaging the autoloader.
- 1 Store your cartridges in their storage cases.
- 1 Do not expose your cartridges to direct sunlight or sources of heat, including portable heaters and heating ducts.
- 1 The operating temperature range for your DLTtapeIV cartridges is 50°F to 104°F (10°C to 40°C). The storage temperature range is 60°F to 90°F (16°C to 32°C). Always store your DLTtapeIV cartridges in their storage cases.
- 1 If a cartridge has been exposed to temperatures outside the ranges specified above, stabilize the cartridge at room temperature for the same amount of time it was exposed to extreme temperatures or 24 hours, whichever is less.
- 1 Store your cartridges in a dust-free environment in which relative humidity is always between 20% and 80% (Noncondensing). The ideal storage relative humidity is 40%,  $\pm$  20%.
- 1 Do not place DLTtapeIV cartridges near sources of electromagnetic energy or strong magnetic fields, such as computer monitors, electric motors, speakers, or X-ray equipment. Exposure to electromagnetic energy or magnetic fields can destroy data, rendering the cartridge unusable.
- 1 Place identification labels only in the slide-in slot on the front of the cartridge.

---

## Cleaning the Tape Drive

When the Clean Drive LED is on, the autoloader's tape drive needs to be cleaned. An illuminated **Media Attention LED** or an exclamation point (!) in the inventory display may also indicate that the tape drive needs to be cleaned. Cleaning typically takes several minutes, during which the Ready LED blinks.

Each cleaning cartridge has an approximate life of 20 cleanings. The cleaning cartridge includes a label with 20 small boxes printed on it. Always place a check mark in a box each time you use the cartridge to clean the drive. Replace the cleaning cartridge when all boxes are checked.

The drive cannot keep track of how many times a cartridge has been used. Therefore, if you are using backup software to manage cleaning, then you must monitor the software logs or use some other method to determine when you need to replace the cleaning tape. Refer to the backup software documentation for more information. Also refer to the backup software documentation for information on enabling automatic or scheduled cleanings with the use of a dedicated cleaning slot.





**NOTICE:** Use only DLT1 compatible cleaning cartridges in the autoloader, available at [www.dell.com/tapebackup](http://www.dell.com/tapebackup). Use of any other type of cleaning cartridge could damage the read/write head in the tape drive. Therefore, if you load any other type of cleaning cartridge, the autoloader will automatically unload it back into its original slot within approximately 25 seconds.



**NOTE:** If you are using Operator's Panel commands to clean the drive, import the cleaning cartridge only after you have selected the **Clean Drive** command. If you would like to keep a cleaning cartridge in the autoloader, the backup software must manage drive cleaning.

To clean the tape drive, follow these steps:

1. From the Home screen or main menu, press **+** or **-** until **Commands** appears on the top line of the LCD screen, and then press **Enter**.

2. Press + or - until **Clean Drive** appears on the LCD screen, and then press **Enter**.
  3. If the carousel is full, the LCD screen displays **No slot free for transfer**. Press **Cancel** repeatedly until the main menu or Home screen is displayed. Export a cartridge to make room for the cleaning cartridge (see [Exporting Cartridges](#)), then return to step 1 to clean the tape drive.
  4. If the carousel is not full, the autoloader will select the first available slot and prompt you to insert a cleaning cartridge.
  5. Insert the cleaning cartridge into the autoloader media door.
  6. During the cleaning process, which can take several minutes, the LCD screen displays **Drive Cleaning**.  
 **NOTE:** If the cartridge is not a valid cleaning cartridge, the LCD screen will display **Bad clean tape** and the cartridge is ejected.
  7. When tape drive cleaning is complete, the Clean Drive LED turns off, if previously on, and the autoloader unloads and exports the cleaning cartridge. Remove the cleaning cartridge, and press **Enter** when the LCD screen prompts you to do so.  
 **NOTICE:** If the Clean Drive or Media Attention LED is illuminated again when you insert another cartridge immediately after cleaning, see ["Troubleshooting"](#).
  8. If you had to remove a data cartridge to import the cleaning cartridge, import that data cartridge to its original slot (see ["Importing Cartridges"](#)).
- 

## Creating an Inventory of Cartridges

This option builds a new inventory of cartridges in the autoloader. If using a bar code reader, this option also scans the bar code labels on each cartridge in the carousel (see ["Bar Code Reader"](#)). To use this option, follow these steps:

1. From the Home screen or main menu, press + or - until **Commands** appears on the top line of the LCD screen.
  2. Press **Enter** to access the available options.
  3. Press + or - until **Re-inventory** appears on the LCD screen, and then press **Enter**.
  4. The autoloader will then check the drive and each slot for the presence of a tape in order to update the inventory information.
- 

[Back to Contents Page](#)

[Back to Contents Page](#)

## Regulatory: Dell™ PowerVault™ 122T DLT VS80 Autoloader User's Guide

- [UL and CUL Listing](#)
  - [CE Compliance](#)
  - [FCC Compliance Statement](#)
  - [Industry Canada \(Digital Apparatus\)](#)
  - [Manufacturer Declaration](#)
- 

### UL and CUL Listing

This information technology equipment is UL-Listed and CUL-Listed for use with UL-Listed personal computers that have installation instructions detailing user installation of card cage accessories.

---

### CE Compliance

#### Electromagnetic Compatibility

This device complies with the following standards in accordance with the European Directives 89/336/EEC.

- 1 Immunity EN 55024:1998
- 1 Emission EN 55022, Class A:1994 + A1:1995 + A2: 1997

#### Safety (Low Voltage Directive)

This device complies with the following standards in accordance with European Directives 73/23/EEC

- 1 EN 60950:2000

These definitions are classified as per safety standard:

- 1 EN 60950:2000
  - 1 SELV: Safety Extra Low Voltage
- 

### FCC Compliance Statement

This equipment has been tested and found to comply with the limits for a Class A digital device, pursuant to Part 15 of the FCC rules. These limits are designed to provide reasonable protection against harmful interference when the equipment is operated in a commercial environment. This equipment generates, uses, and can radiate radio frequency energy and, if not installed and used in accordance with the instruction manual, may cause harmful interference to radio communications.

Any changes or modifications made to this equipment may void the user's authority to operate this equipment.

Operation of this equipment in a residential area may cause interference in which case the user at his own expense will be required to take whatever measures may be required to correct the interference.

This device complies with Part 15 of the FCC Rules. Operation is subject to the following conditions:

1. This device may not cause harmful interference, and
  2. This device must accept any interference received, including interference that may cause undesired operation.
- 

### Industry Canada (Digital Apparatus)

**Reference:** *Interference-Causing Equipment Standard* ICES-003 Issue 2

This Class A digital apparatus meets all requirements of the Canadian Interference-Causing Equipment Regulations.

Cet appareil numérique de la classe A respecte les toutes les exigences du Règlement sur le matériel brouilleur du Canada.

---

### Manufacturer Declaration

This certifies that this product is in compliance with EU Directive 89/336/EEC, using the EMC standards EN55022 (Class A) and EN55024. This product also meets or exceeds EN60950 safety requirements. This product has been tested and verified to meet CISPR 22 Class A requirements.

---

[Back to Contents Page](#)



## Technical Specifications: Dell™ PowerVault™ 122T DLT VS80 Autoloader User's Guide

- [Physical Specifications](#)
  - [Autoloader Specifications](#)
  - [Autoloader Environmental Specifications](#)
  - [Tape Drive Specifications](#)
- 

### Physical Specifications

Characteristic Product Alone		Packaged
Height	8.4 cm (3.34 in)	20.5 cm (8.0 in)
Width	41.9 cm (16.5 in)	60 cm (23.6 in)
Depth	60.9 cm (24 in) (Approximately 65 cm (25.6 in) with Bar Code Reader)	74.3 cm (29.2 in)
Weight	10 kg (22 lb)	11.35 kg (24.9 lb)

---

### Autoloader Specifications

Characteristic	Specification
Maximum storage capacity	Native: 320 GB Compressed: 640 GB (assuming 2:1 compression ratio)
Maximum data transfer rate	Native: 3 MB/s Compressed: 6 MB/s (assuming 2:1 compression ratio)
Drive type	1 DLT VS80 drive
Number of slots	8
MSBF	250,000 hours
Interface	LVD ultra wide SCSI-2, 16 bits wide, 68-pin HD connector

---

### Autoloader Environmental Specifications

Characteristic	Specification
<b>Temperature/humidity</b>	
Operating	10° to 40°C (Web bulb temp, 32°C max)
Non-operating	-40° to 65°C (Web bulb temp, 40°C max)
Recommended operating temperature	20° to 30°C (Web bulb temp, 30°C max)
Temperature shock immunity - maximum rate of change	10°C per hour
<b>Humidity</b>	
Operating	20% to 80% RH non-condensing
Non-operating	10% to 95% RH non-condensing
<b>Altitude</b>	
Operating	0 to 4000 m
Non-operating	0 to 9144 m
<b>Vibration (5–500 Hz)</b>	
Maximum acceleration to operating	0.25g RMS (random)
Frequency range	500 Hz

---

### Tape Drive Specifications

#### DLT VS80 Drive Specifications

Description	DLT1 (VS80)
Read/write transfer rate: maximum sustained (DLTtape™IV media)	Non-compressed mode: 3.0 MB/s Compressed (2:1 typical): 6.0 MB/s
Burst transfer rate	20 MB/s
Average access time	68 seconds
Loading time to BOT (for previously written tape)	59 seconds (average)
Unloading time from BOT	17 seconds (average)
MTBF	>200,000 hours
Interface type	Low-Voltage Differential (LVD) Ultra 2 SCSI

## Media Specifications

Characteristic	DLTtapeIV Media
DLT1 formatted capacity	40 GB (non-compressed) 80 GB (2:1 typical compression)
Basic description	0.5 inch (metal particle)
Tape length	557 m (1828 ft)
Cartridge dimensions	10.4 x 10.4 x 2.5 cm (4.1 x 4.1 x 1.0 in)
Shelf life	30 years minimum @ 20°C 40% RH (non-condensing)
Cartridge life	1,000,000 passes (any point on the tape passing the recording head in either direction)
Cleaning cartridge life	20 uses

---

[Back to Contents Page](#)